

Vista

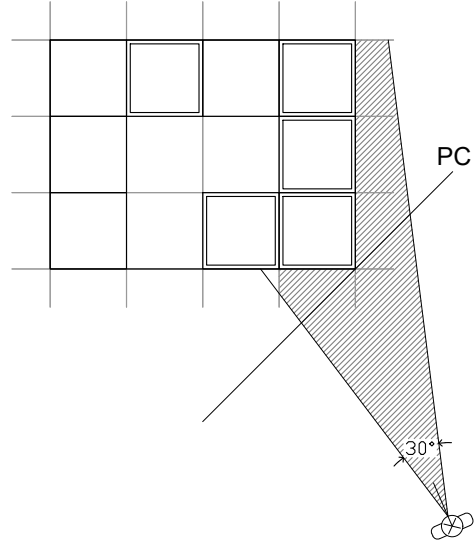

Planta

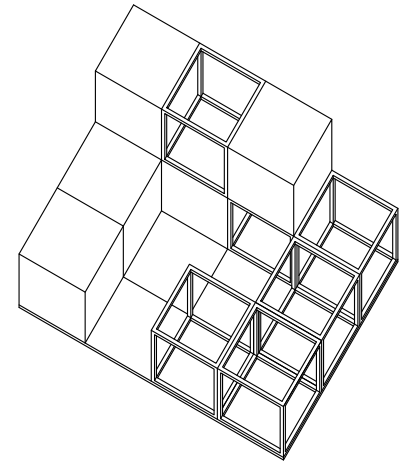

Modelo a dibujar

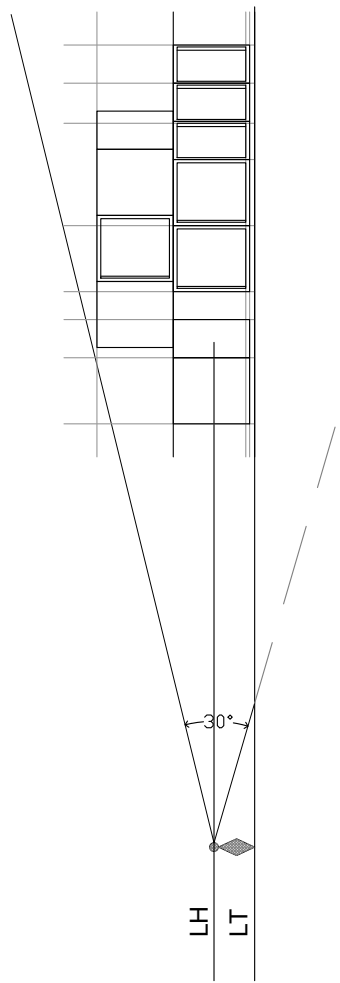

Vista

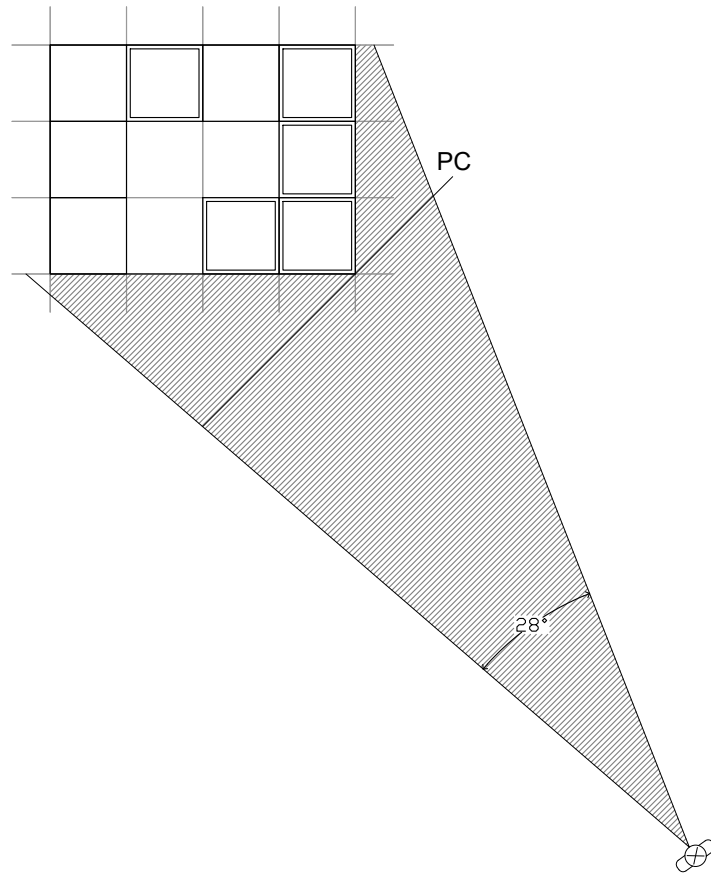

Planta

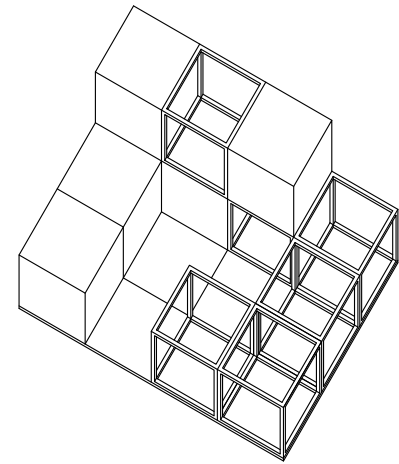

Modelo a dibujar

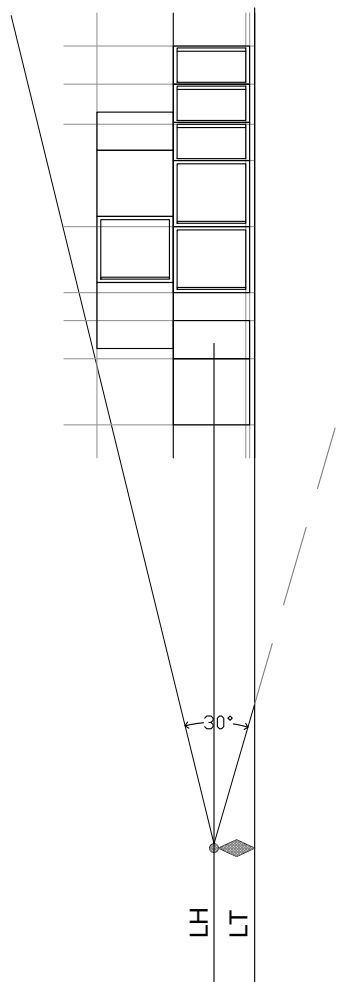

Vista

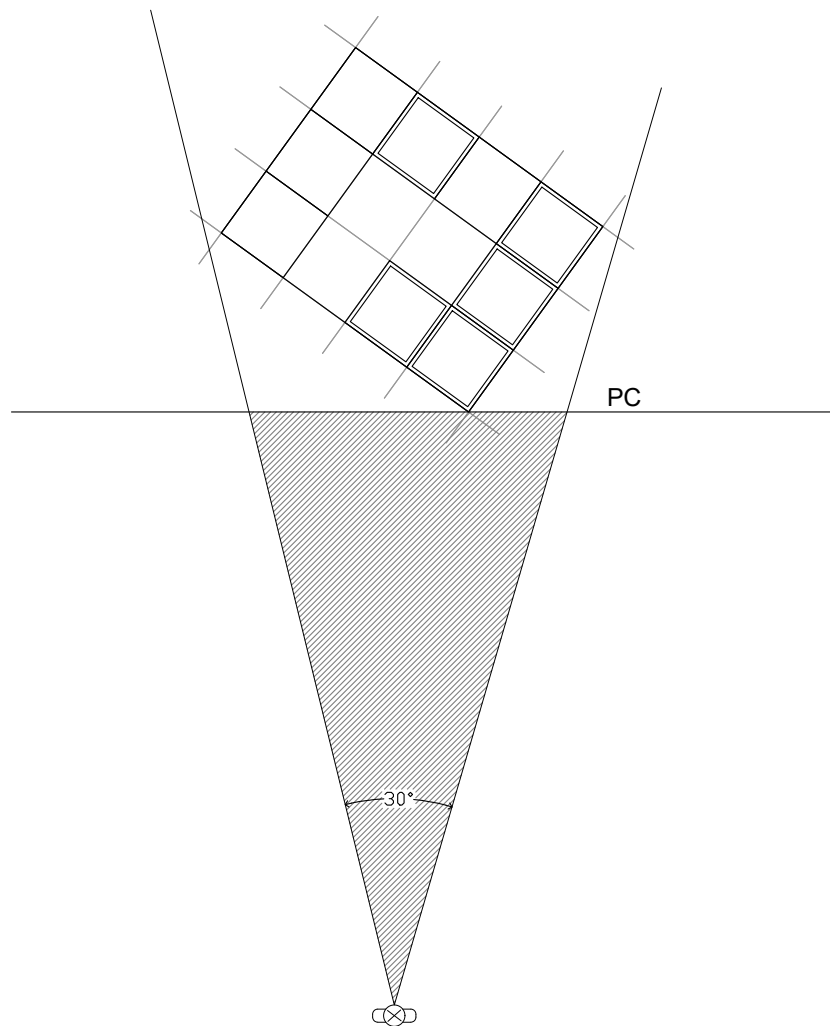

Planta

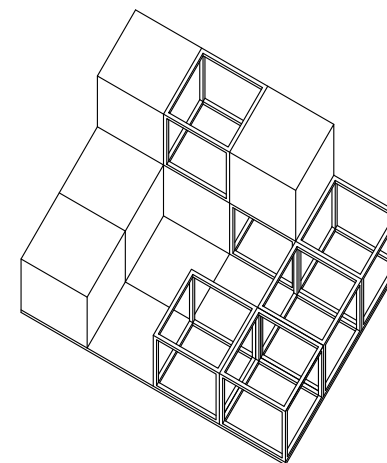

Modelo a dibujar

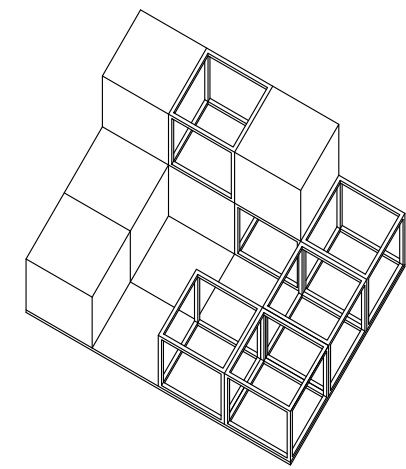
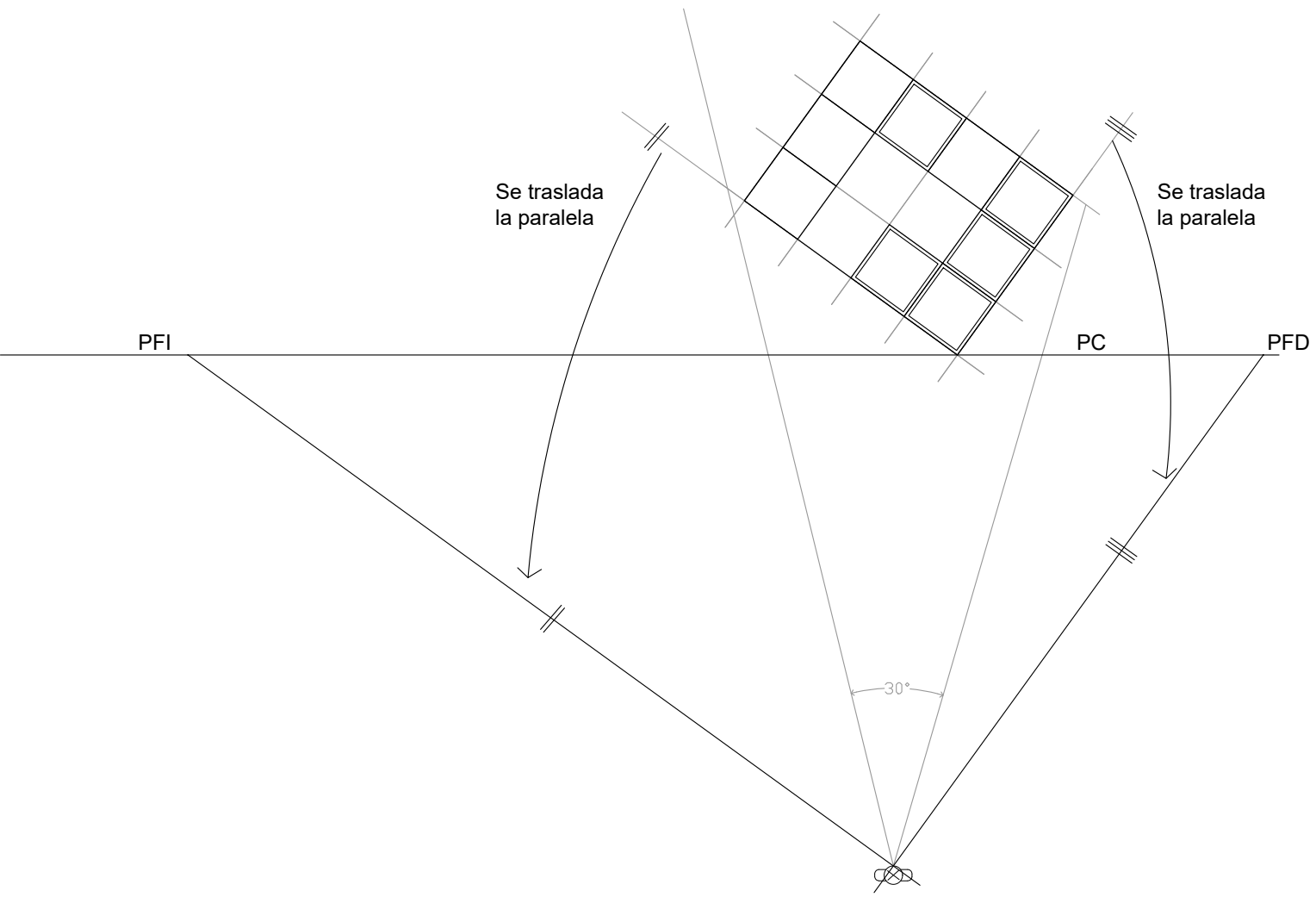

Modelo a dibujar

Planta

Planta

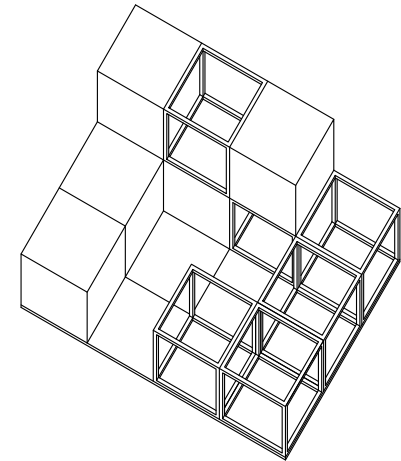
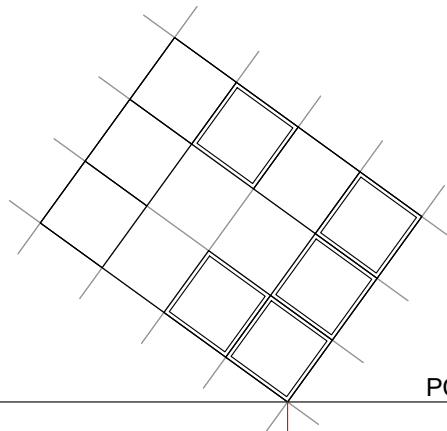

Modelo a dibujar

PFI

PC

PFD

PFI

LH

LT

PFD

6 m

3 m

2 m

Hoja de dibujo

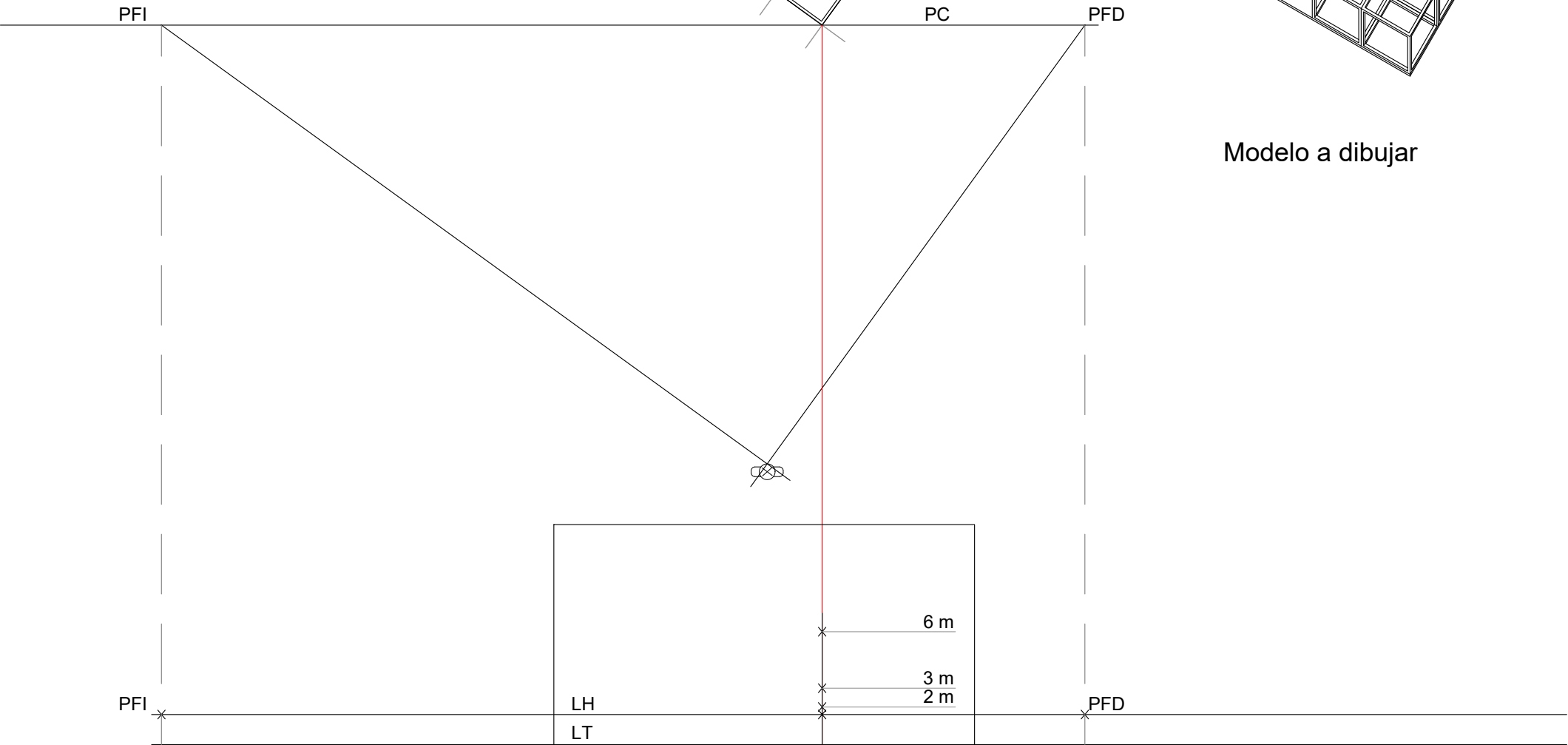

Planta

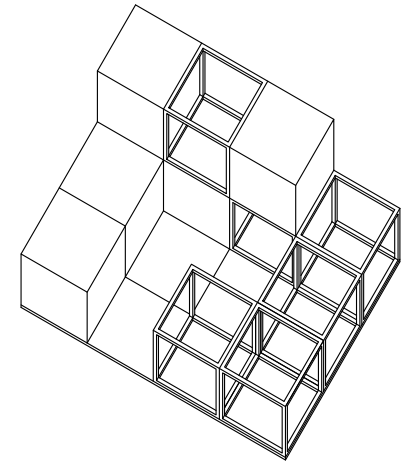
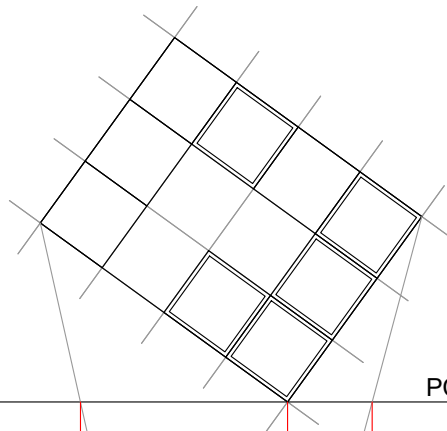

Modelo a dibujar

PFI

PC

PFD



6 m

PFI

LH

LT

PFD

Hoja de dibujo

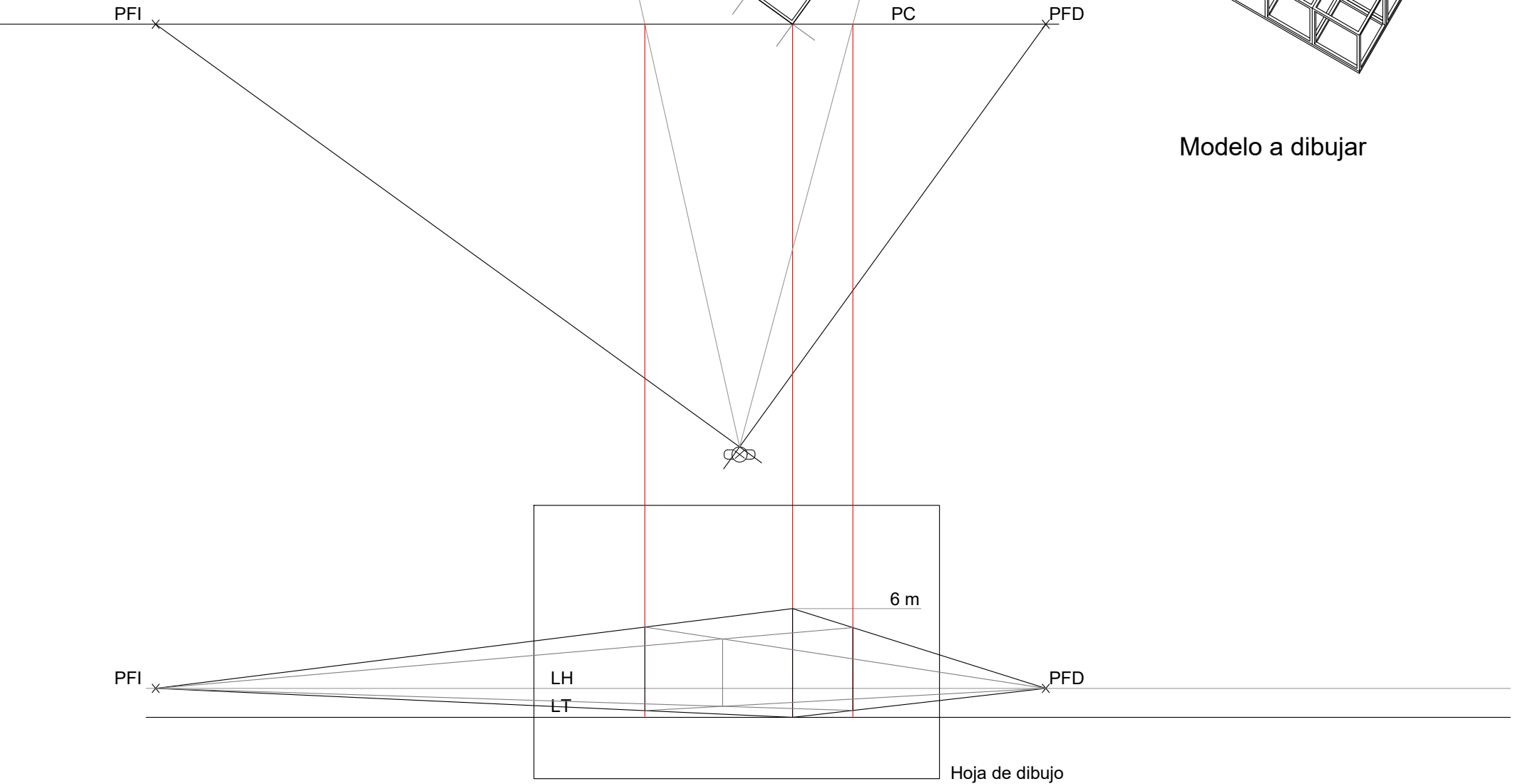

Planta

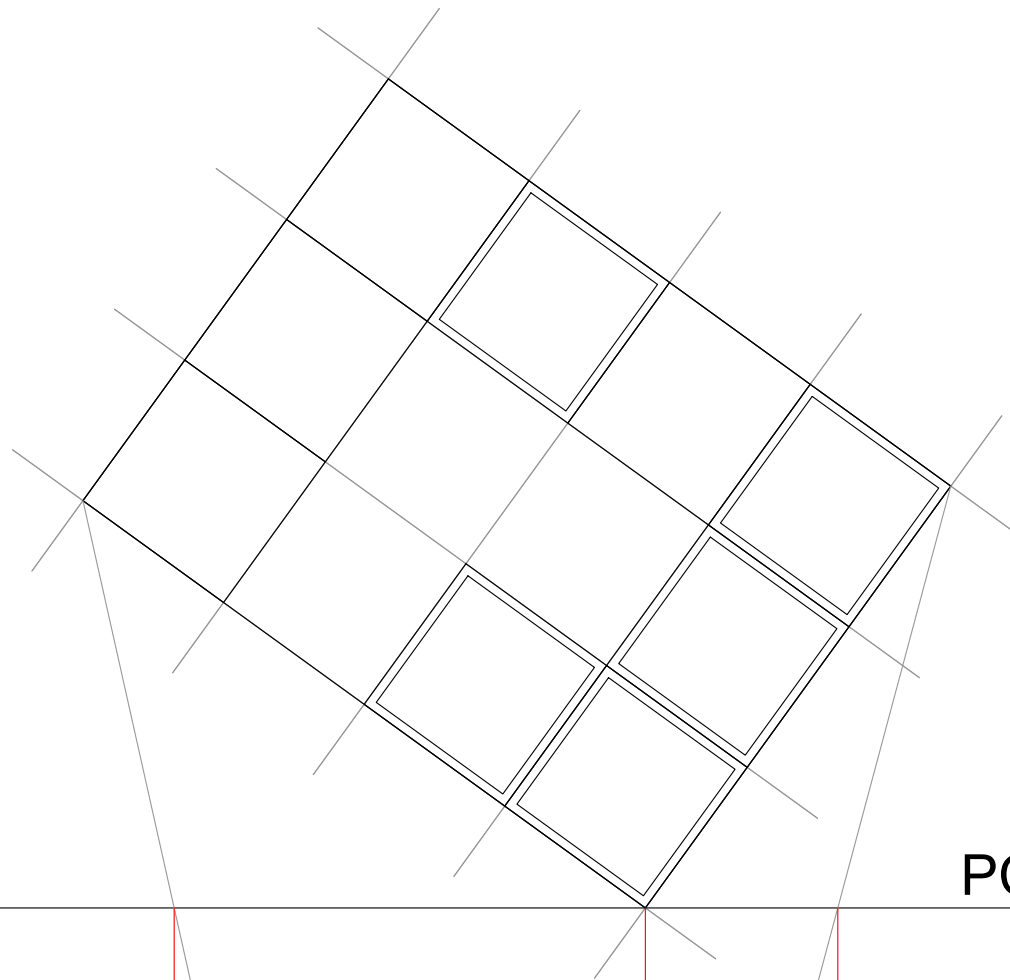

PC

PFD

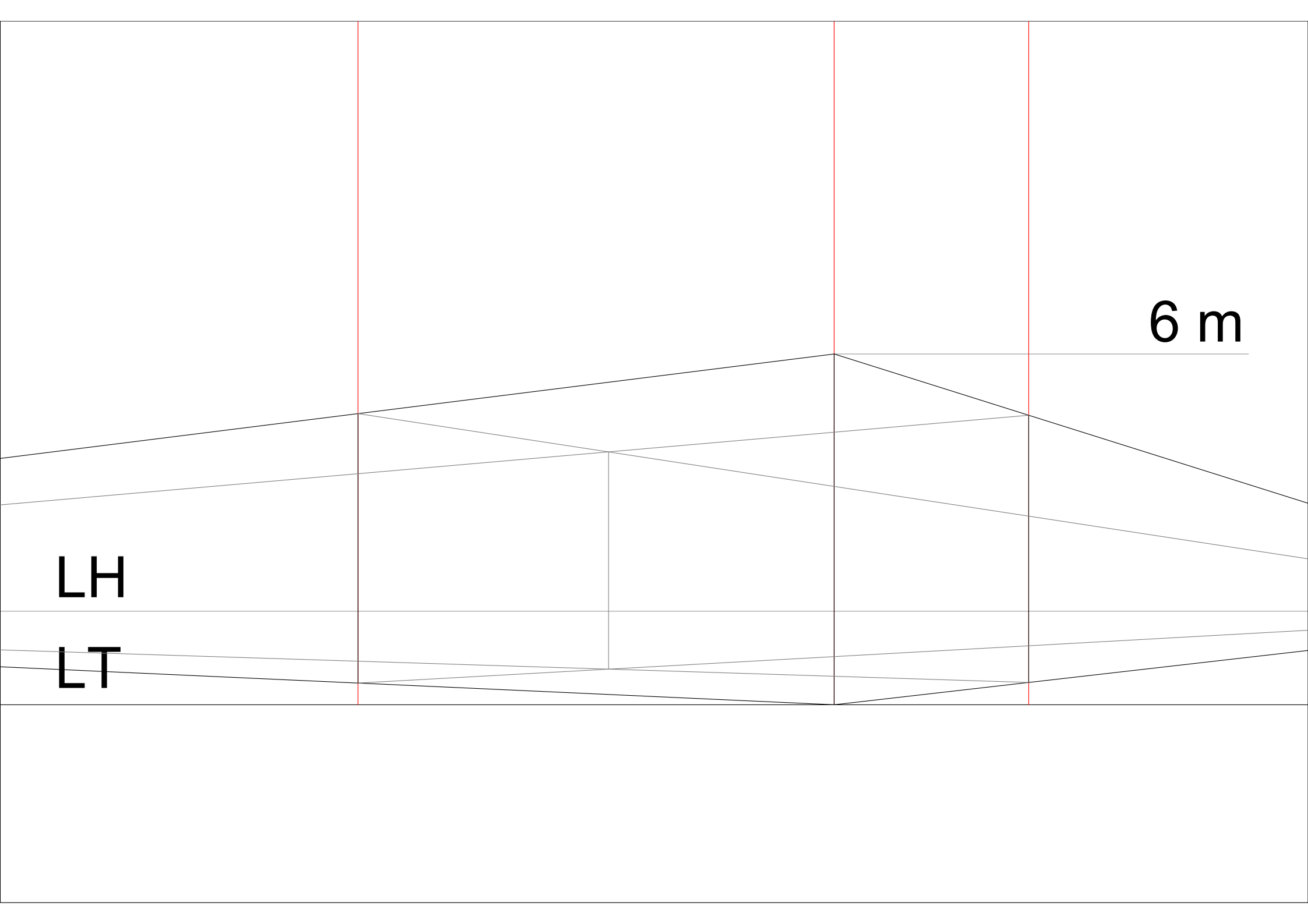

6 m

LH

LT



Planta

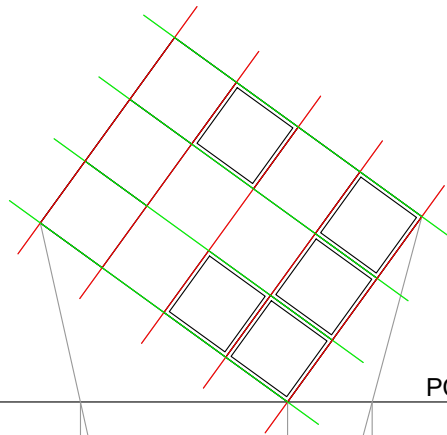

PFI

PC

PFD

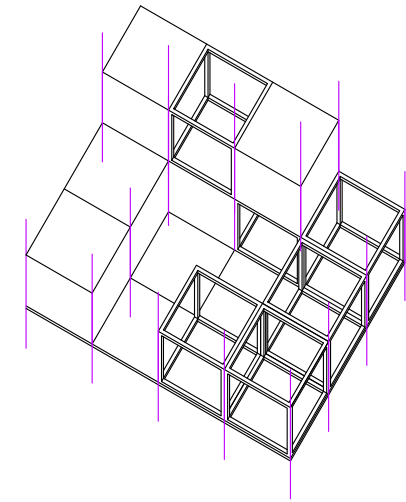

Modelo a dibujar



PFI

LH

LT

PFD

Hoja de dibujo

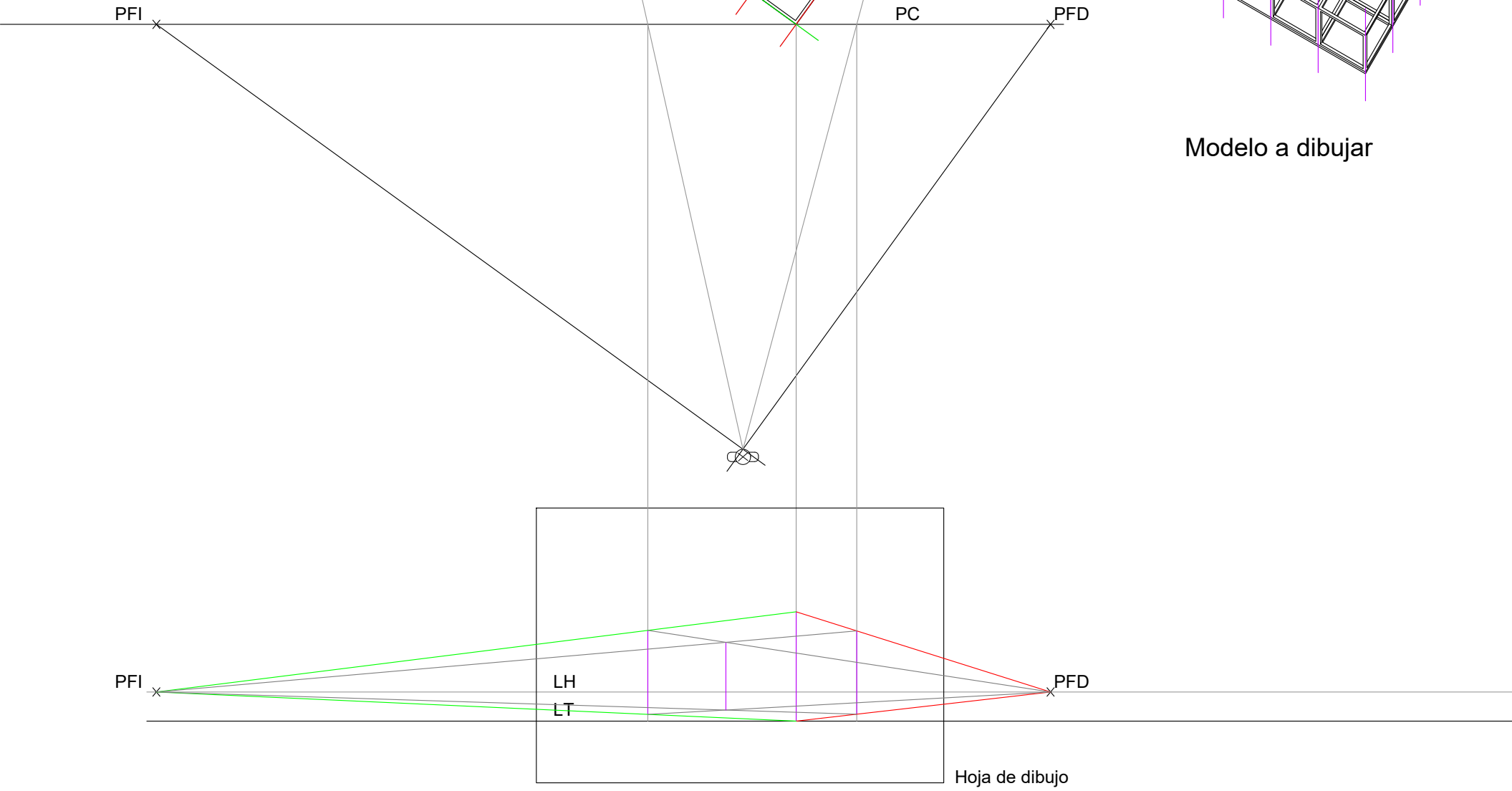

Planta

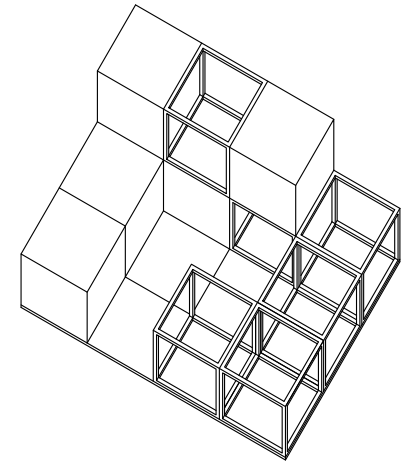
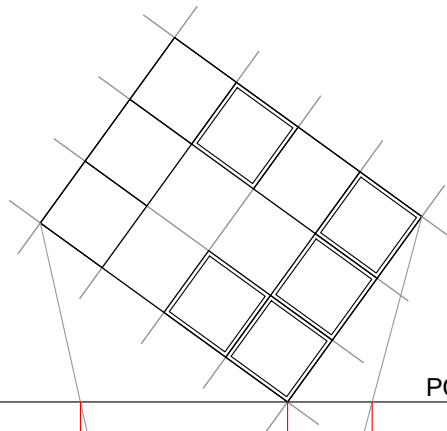

Modelo a dibujar

PFI

PC

PFD



6 m

PFI

LH

LT

PFD

Hoja de dibujo

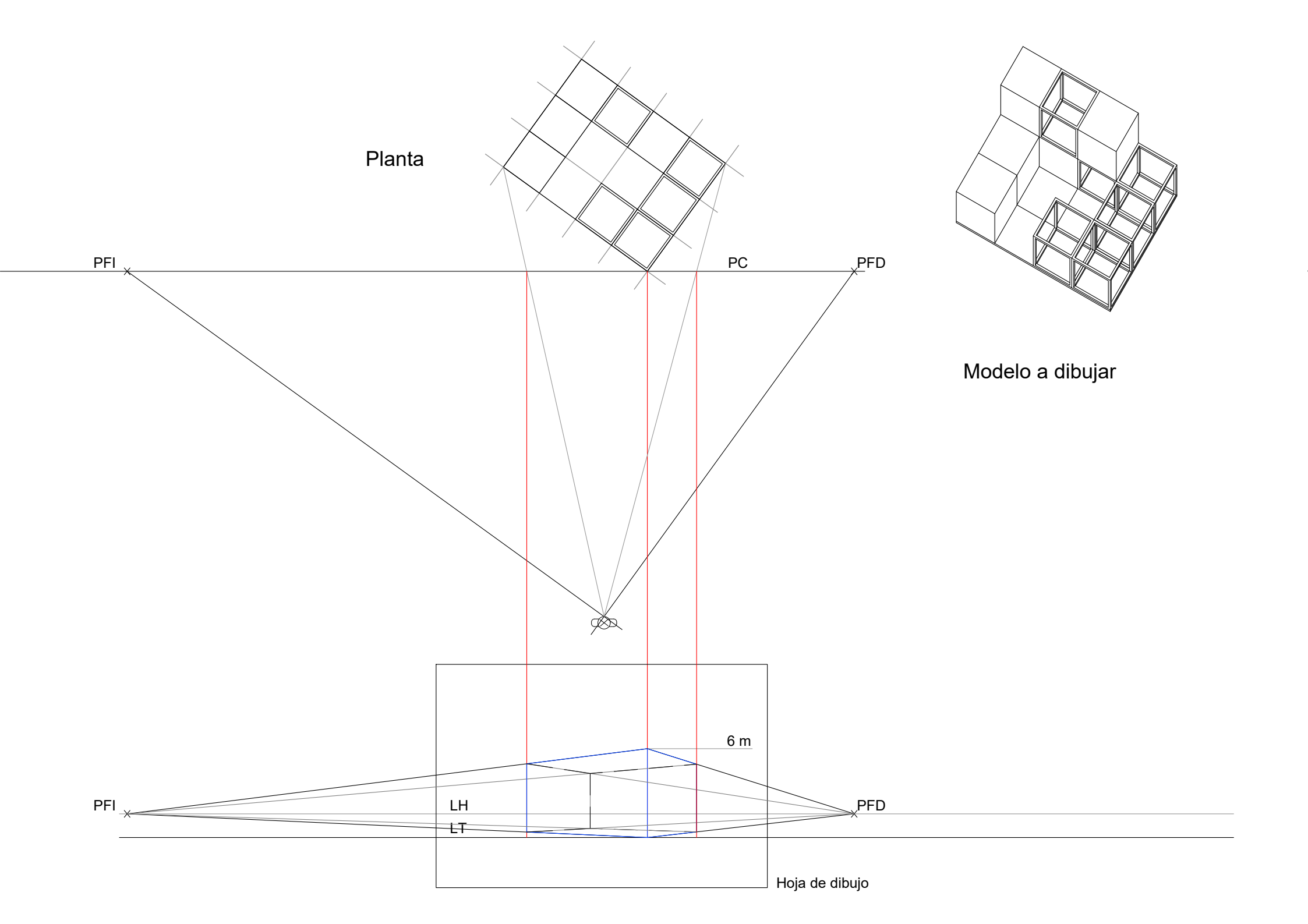

Planta

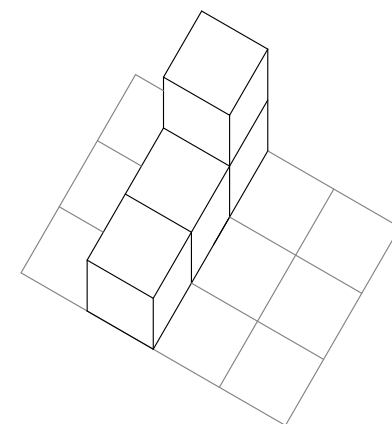
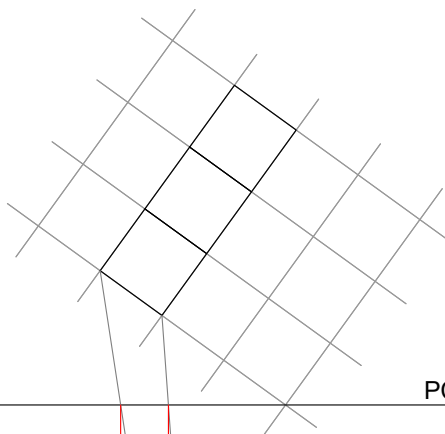

Modelo a dibujar

PFI

PC

PFD



PFI

LH

LT

PFD

Hoja de dibujo

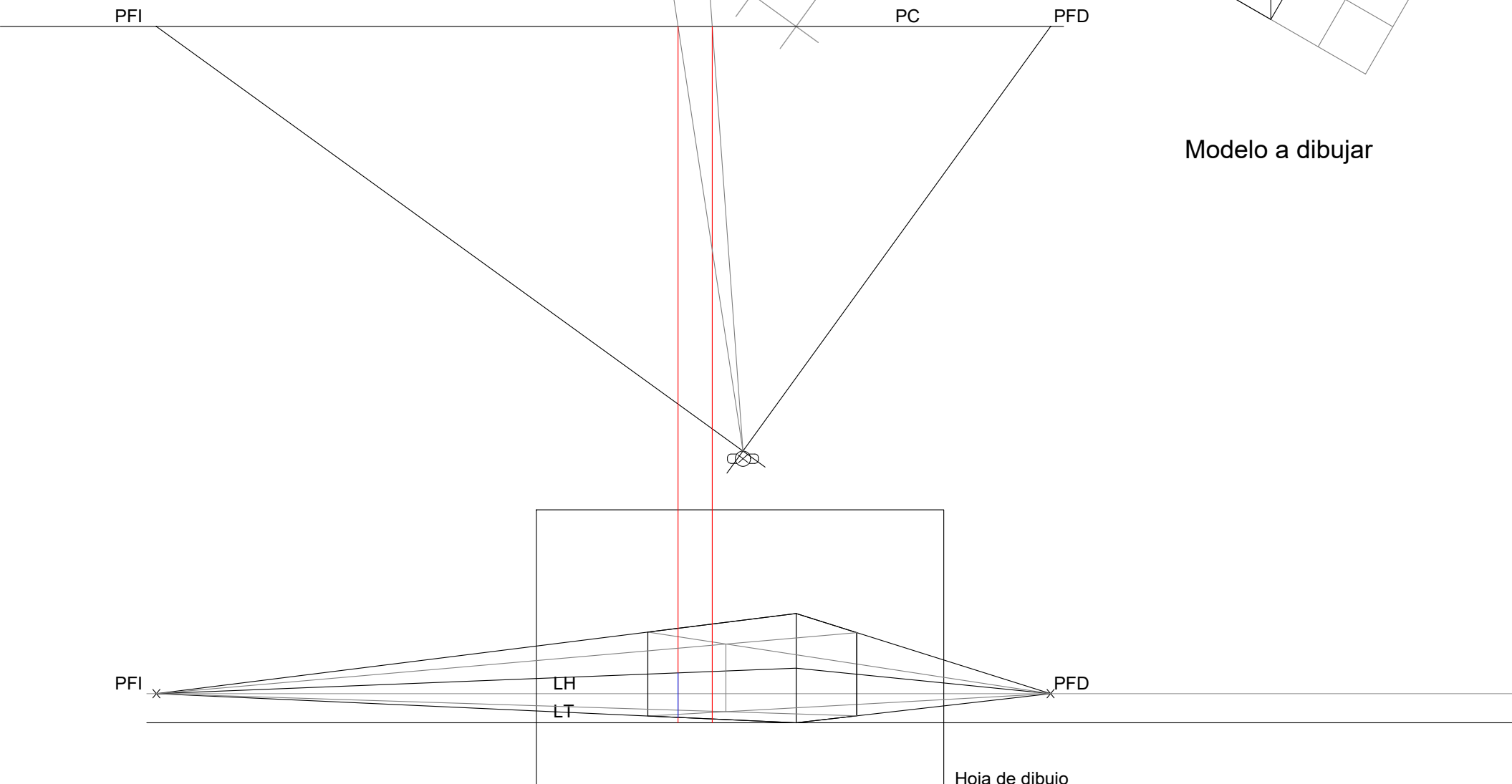

Planta

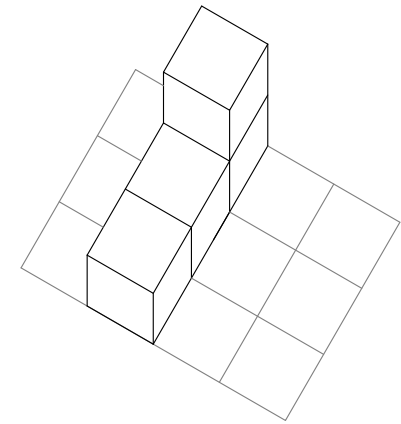
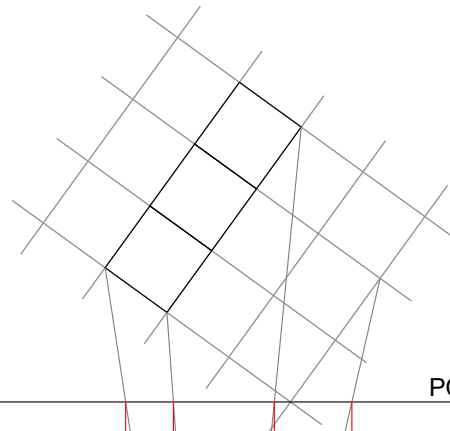

Modelo a dibujar

PFI

PC

PFD



PFI

LH

LT

PFD

Hoja de dibujo

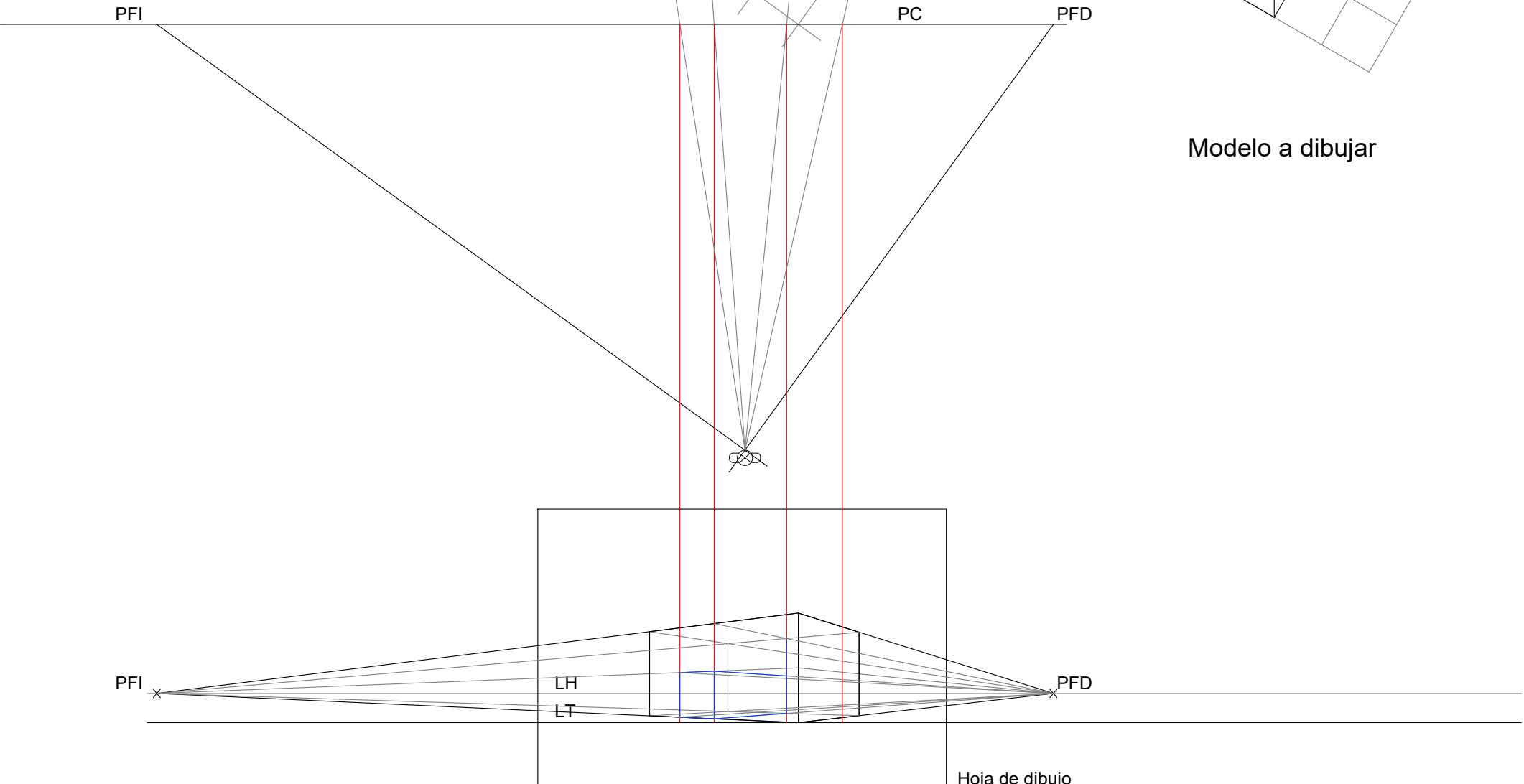

Planta

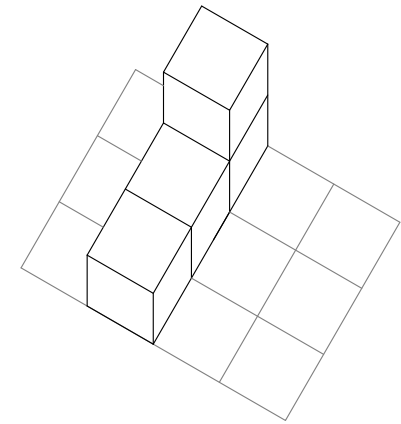
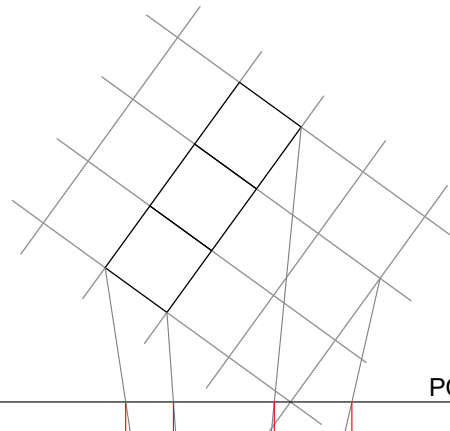

Modelo a dibujar

PFI

PC

PFD



PFI

LH

LT

PFD

Hoja de dibujo

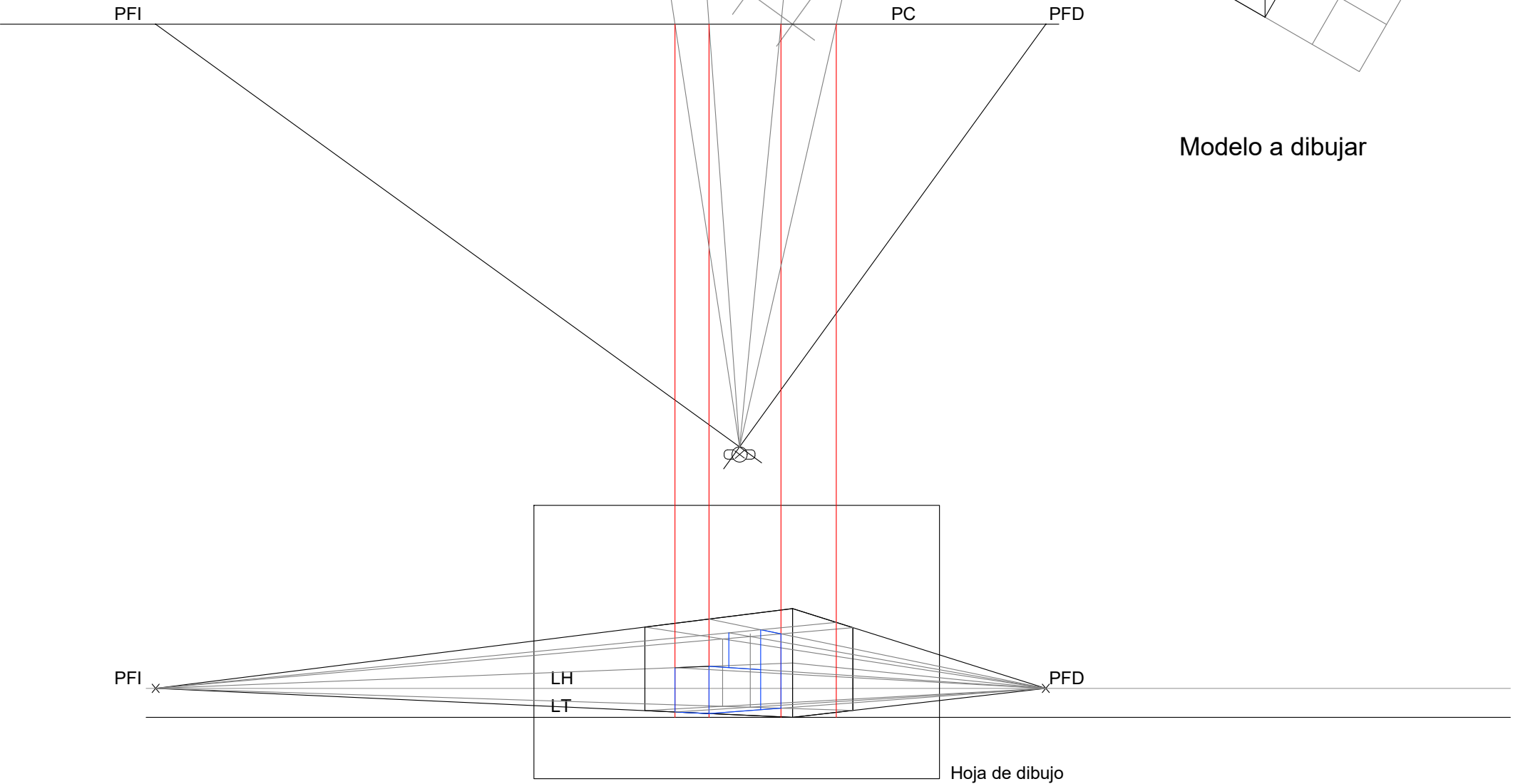

Planta

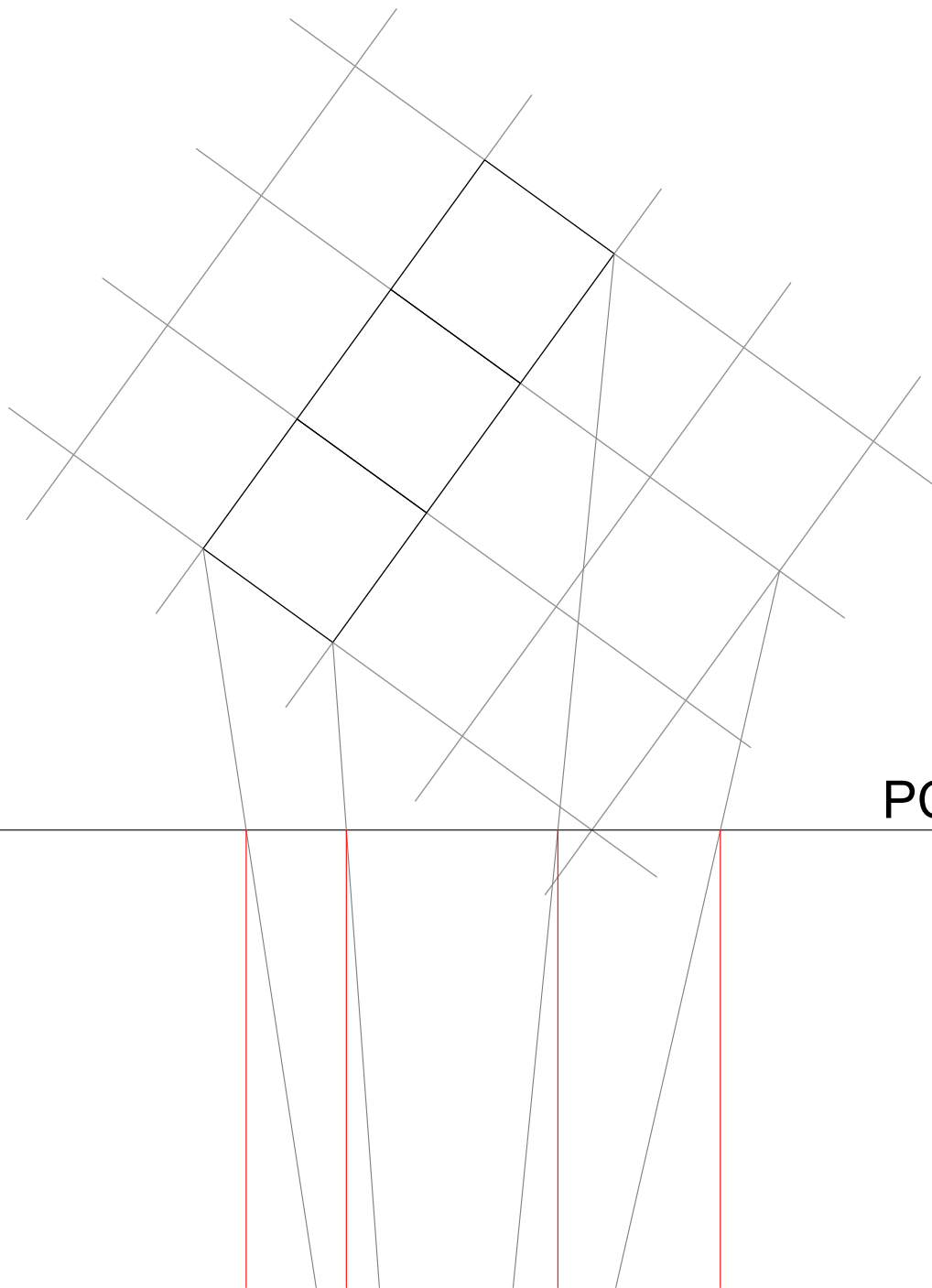

PC

PFD

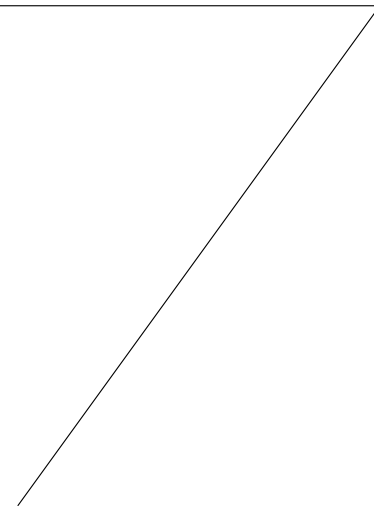

LH

LT

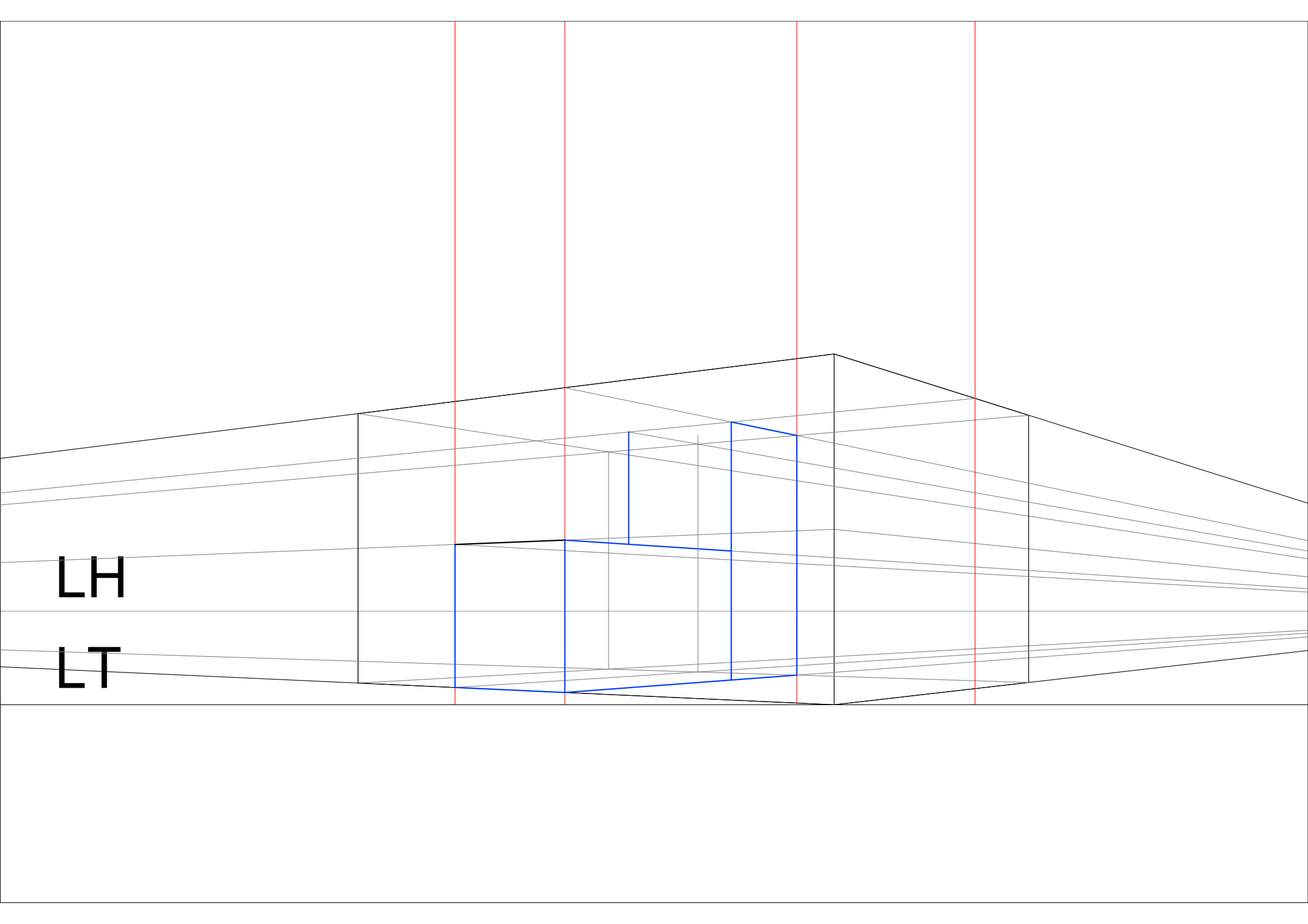

Planta

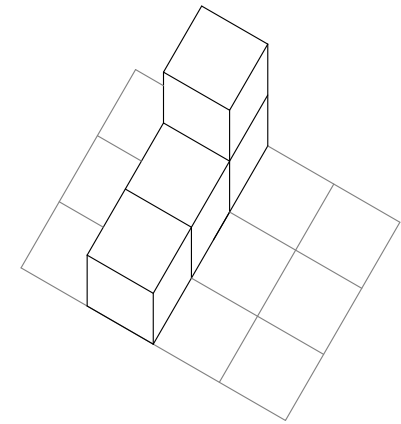
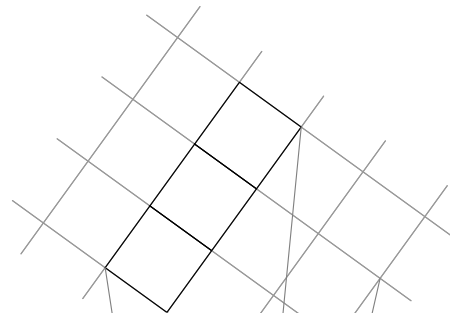

Modelo a dibujar

PFI

PC

PFD



PFI

LH

LT

PFD

Hoja de dibujo

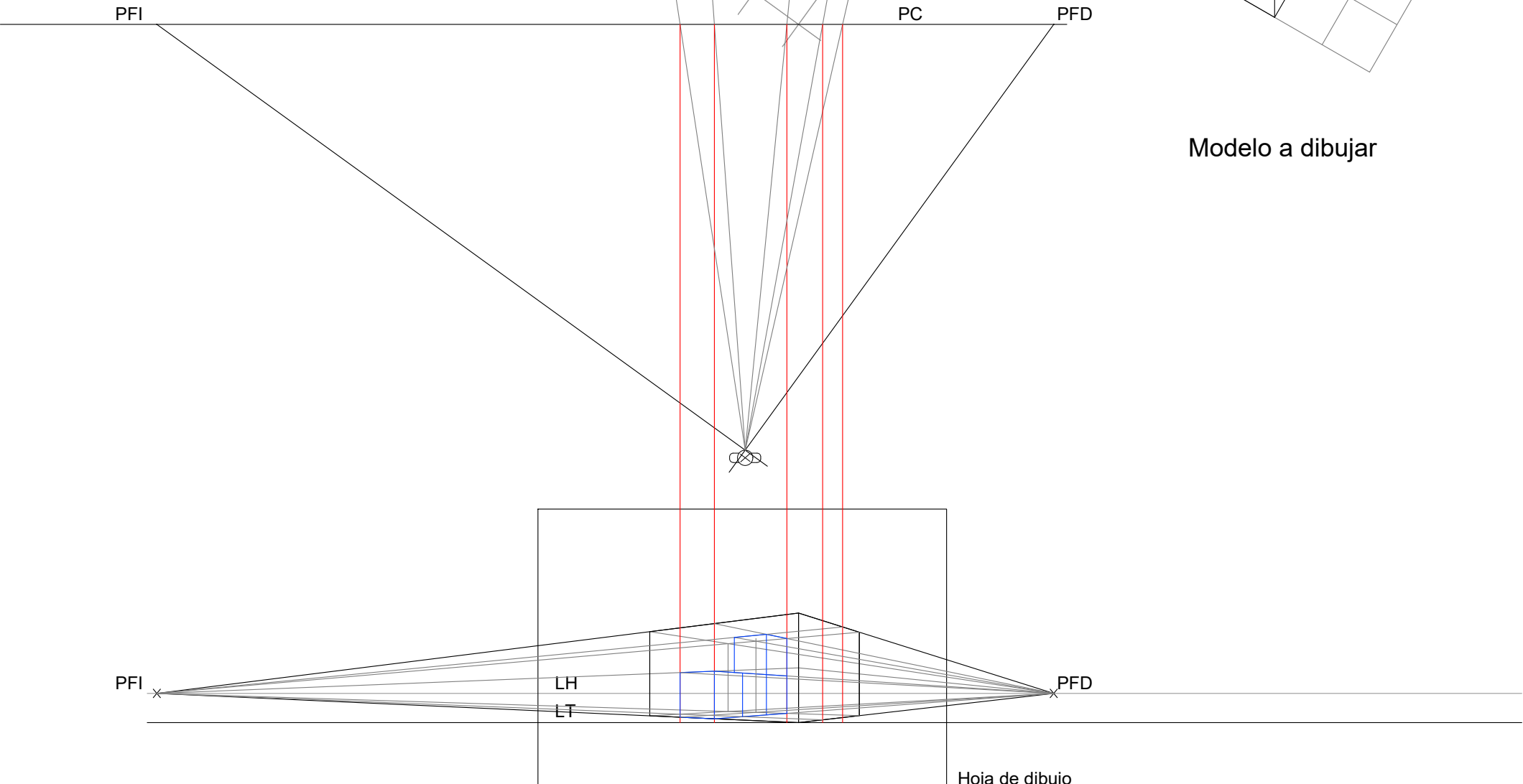



LH

LT

