

Universidad Nacional de Avellaneda

Departamento de Arquitectura, Diseño y Urbanismo | Arquitectura
Sistemas de Representación I

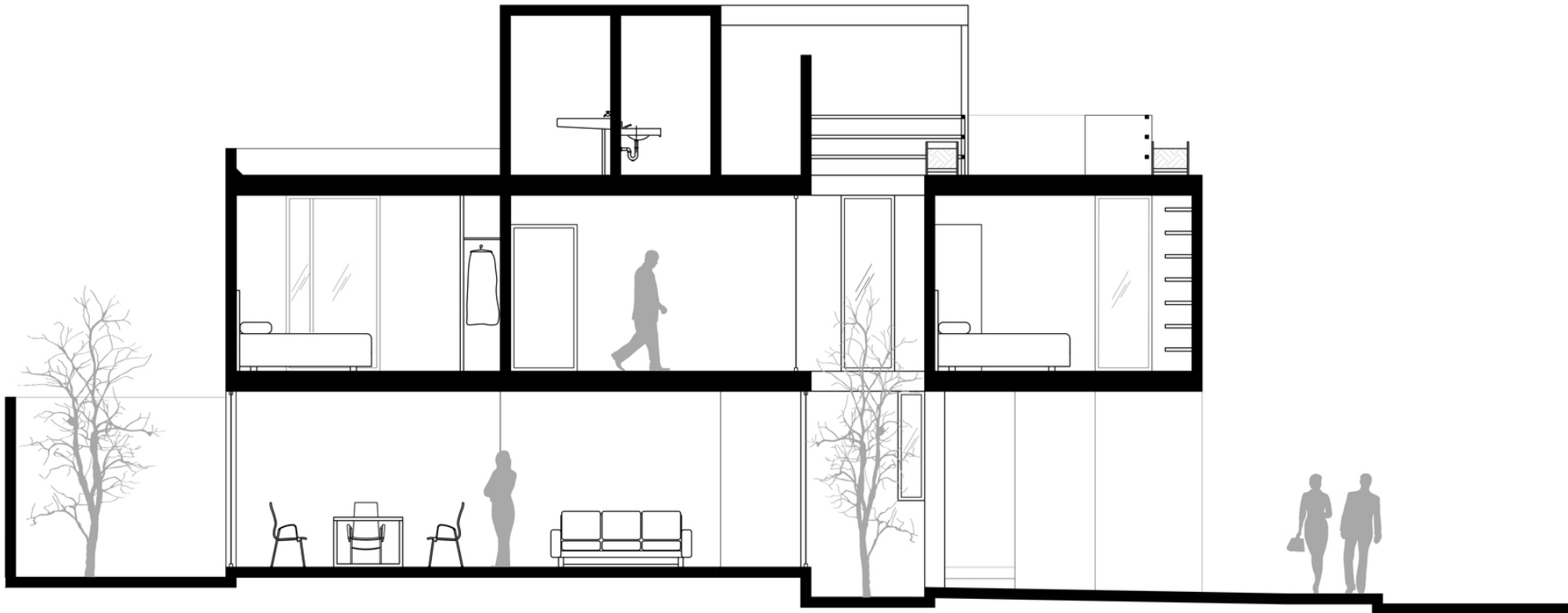

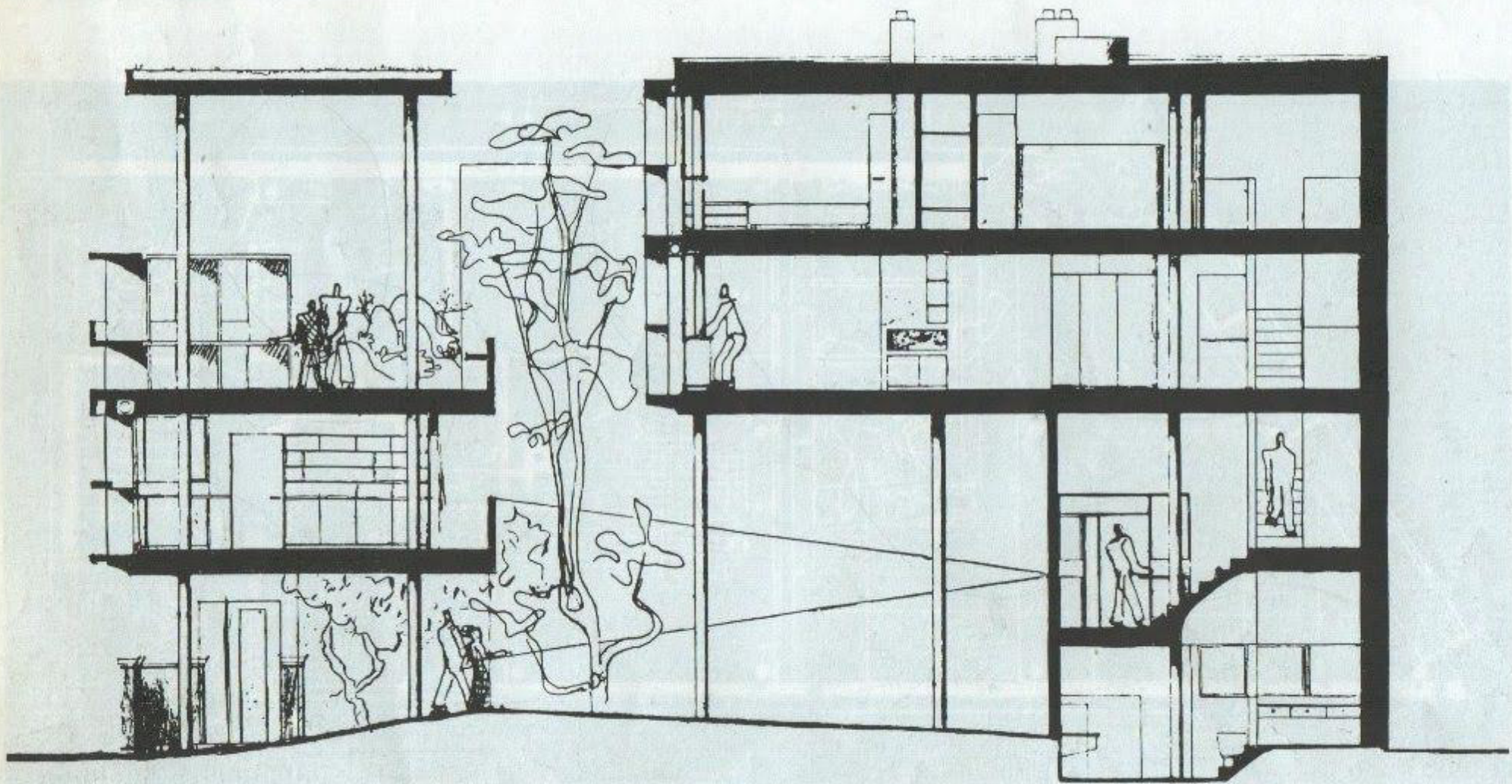



Coupe longitudinale côté rampe

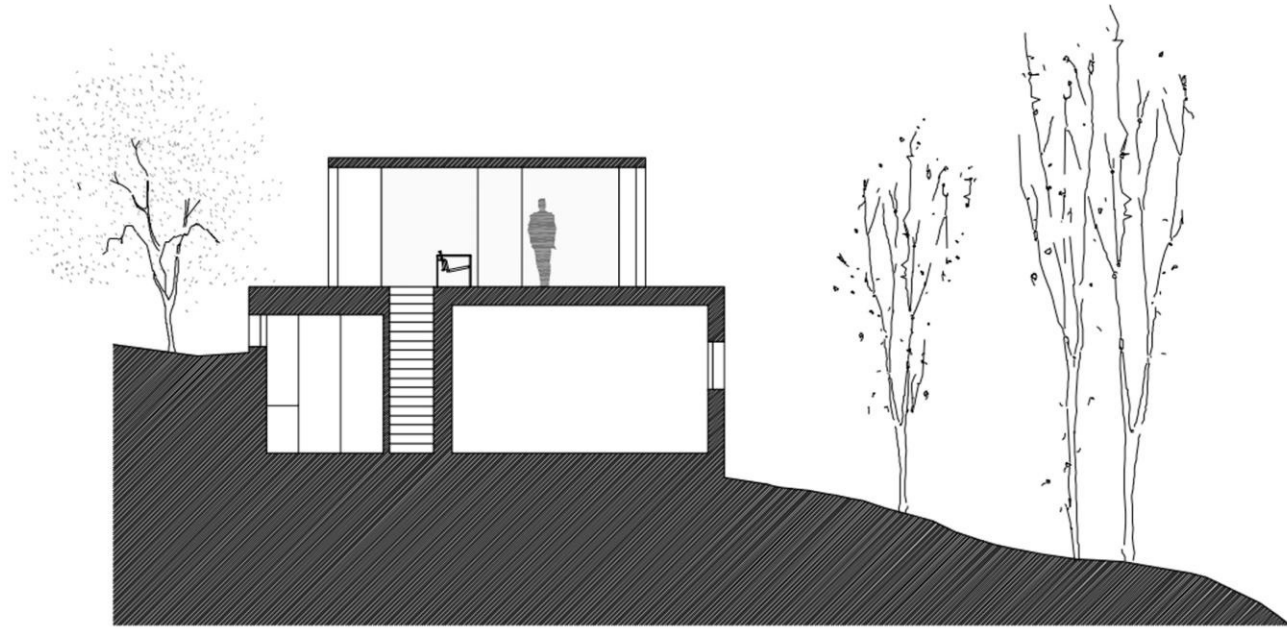

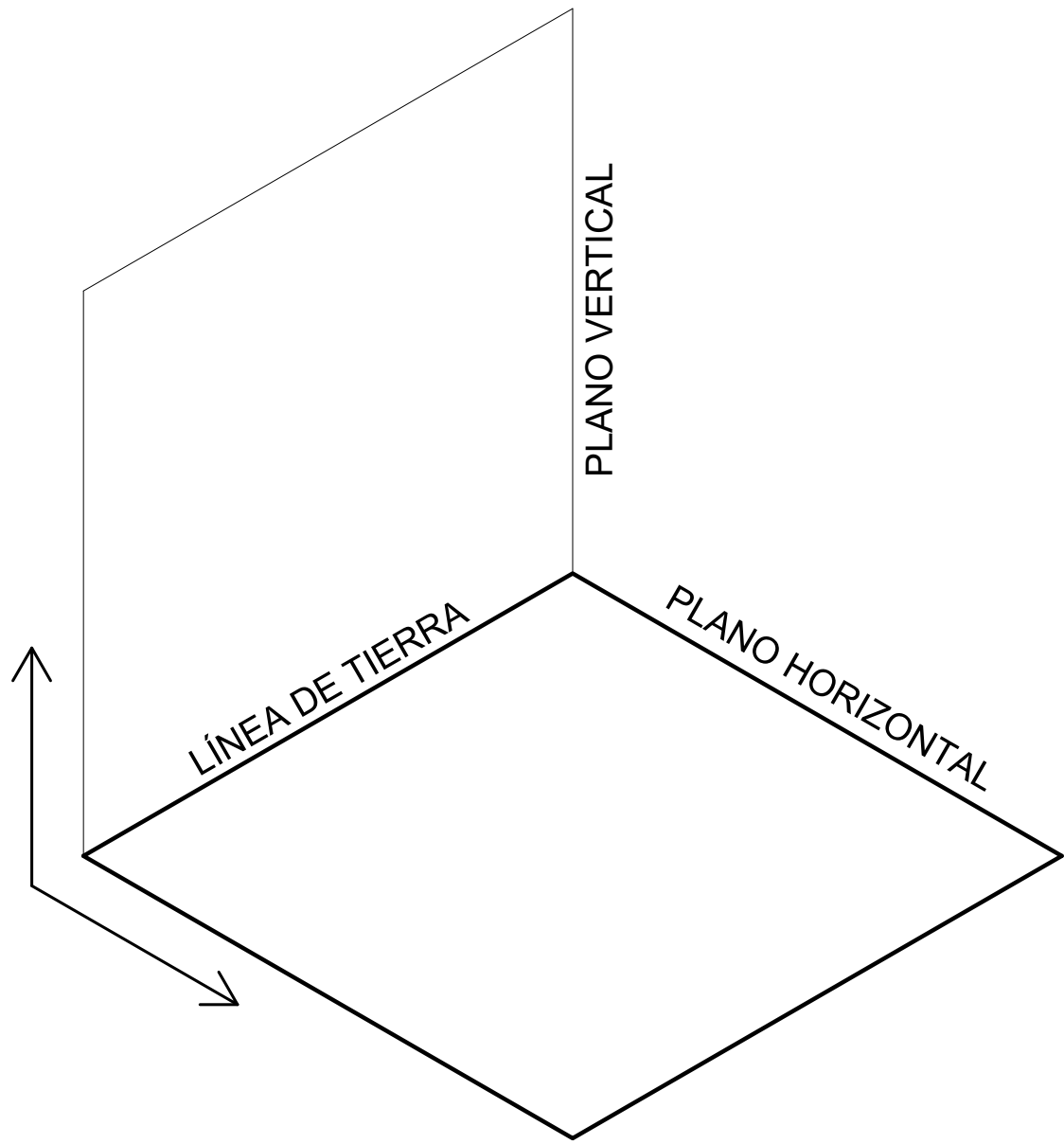

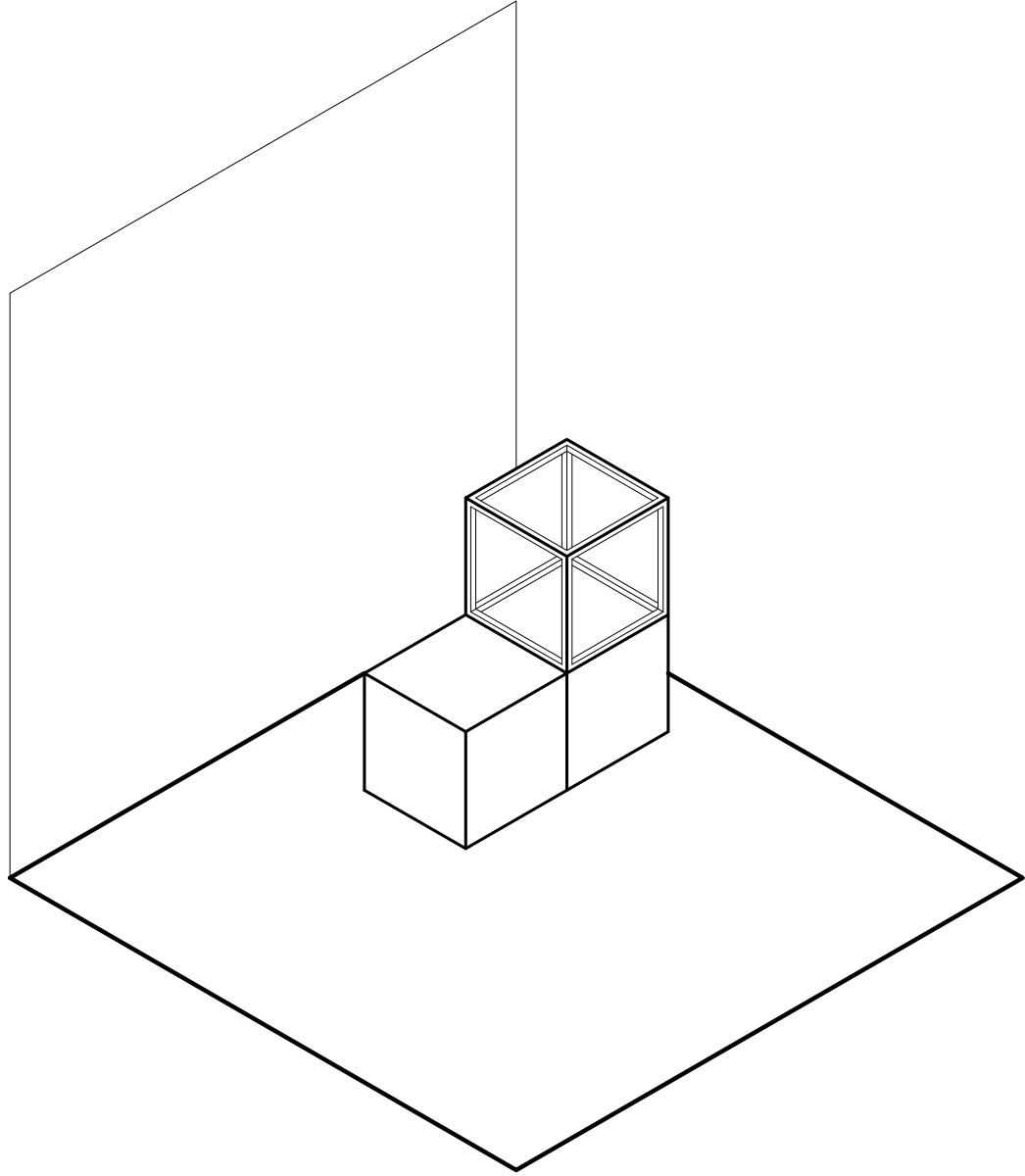

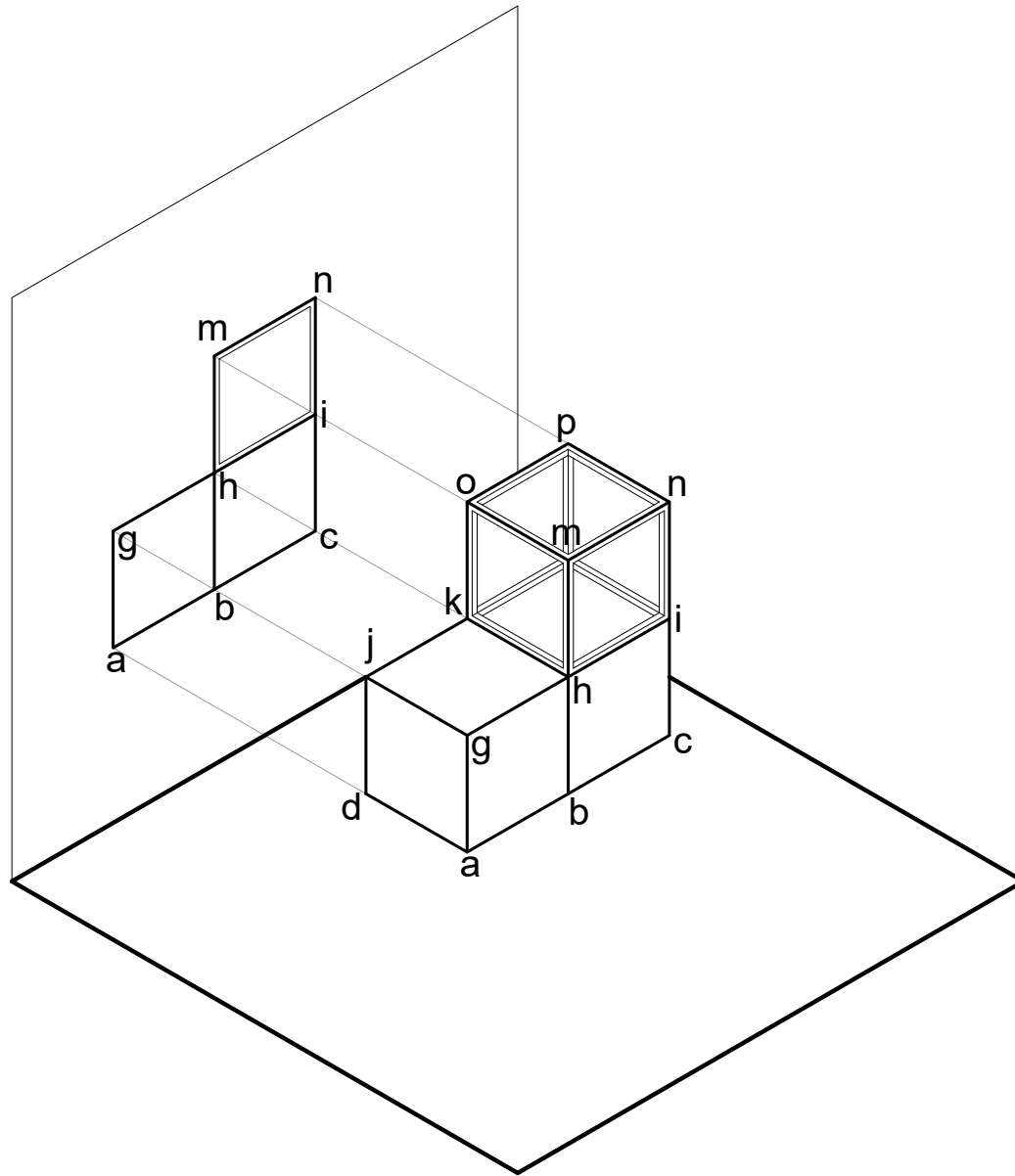

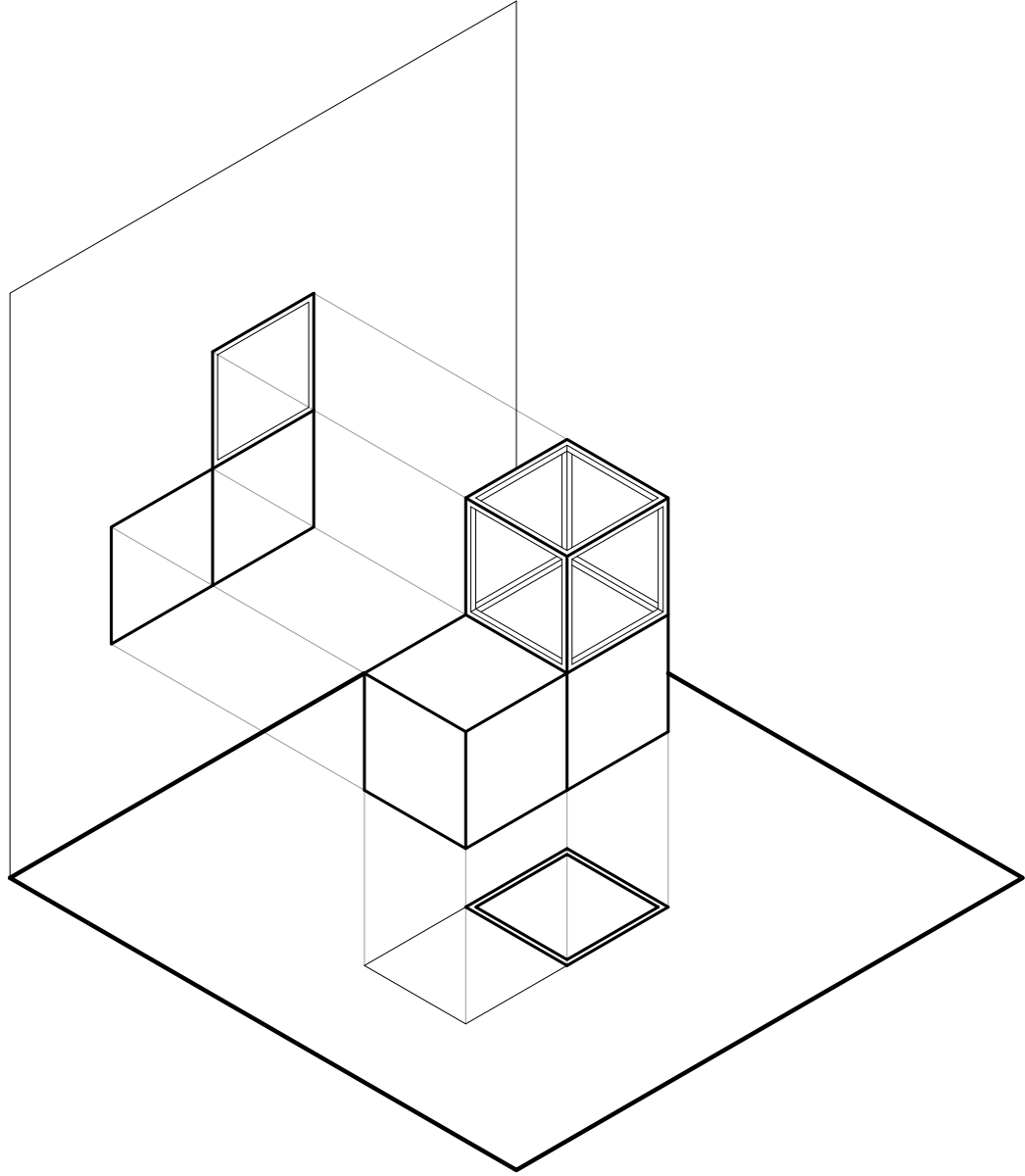

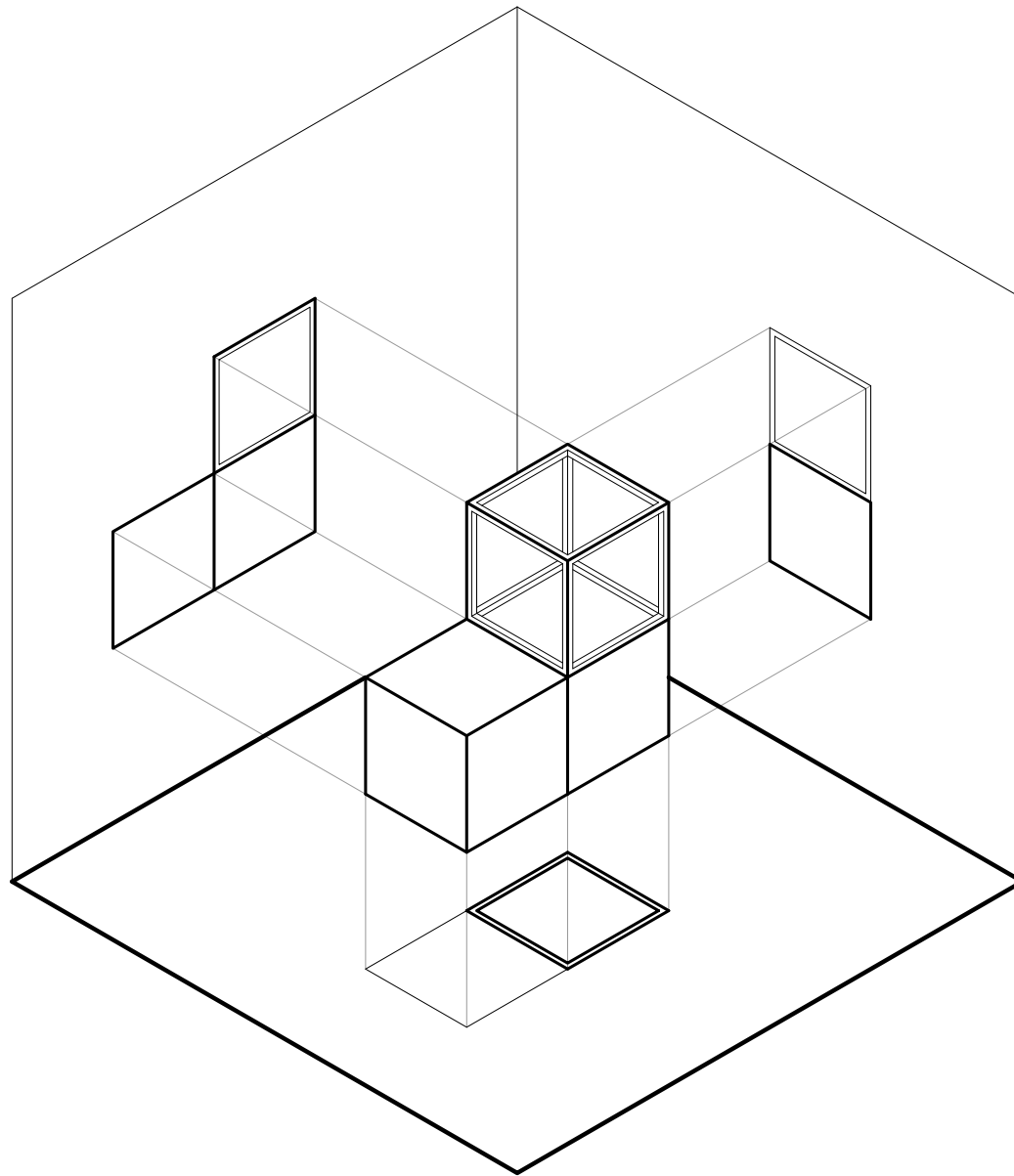

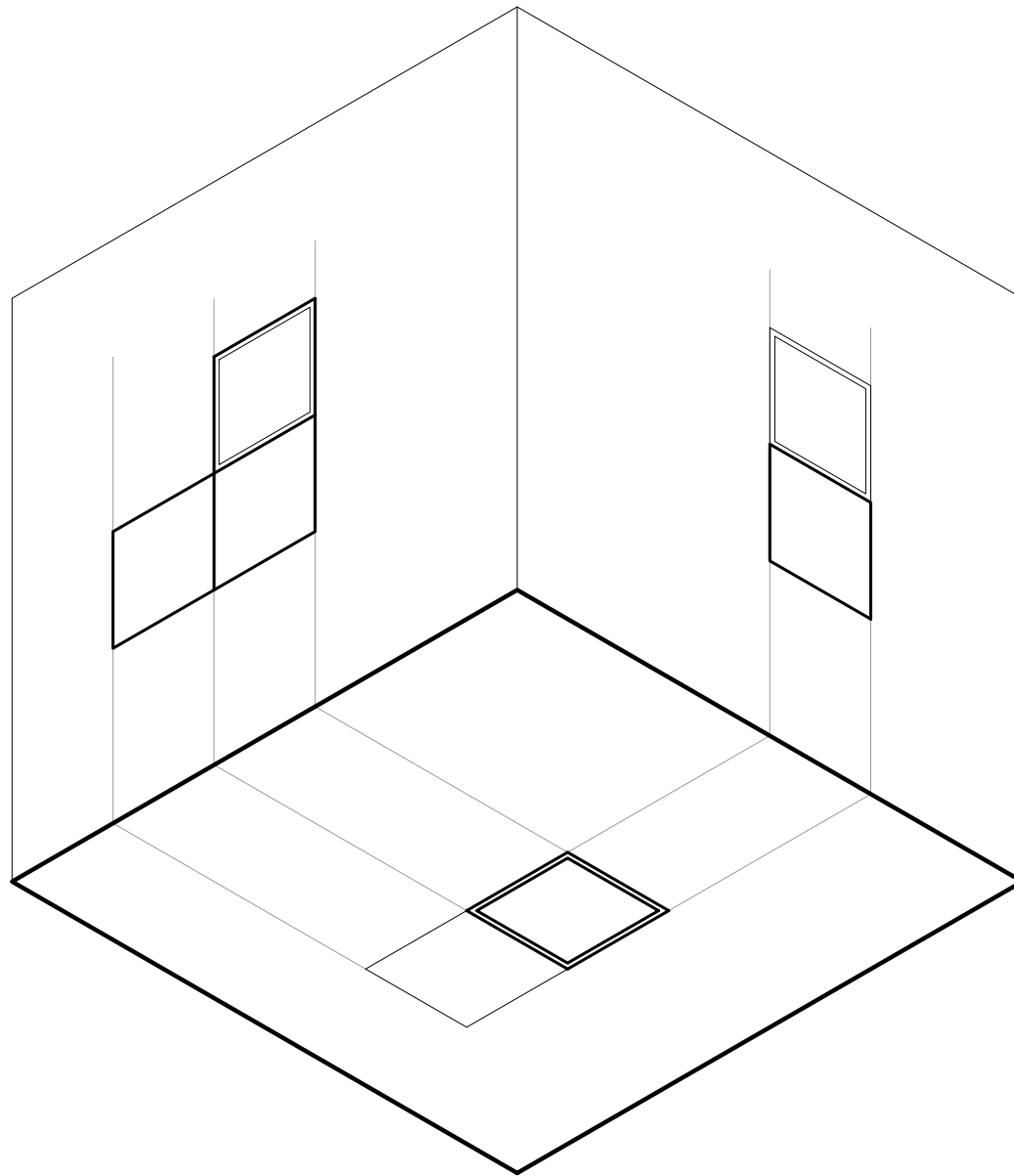

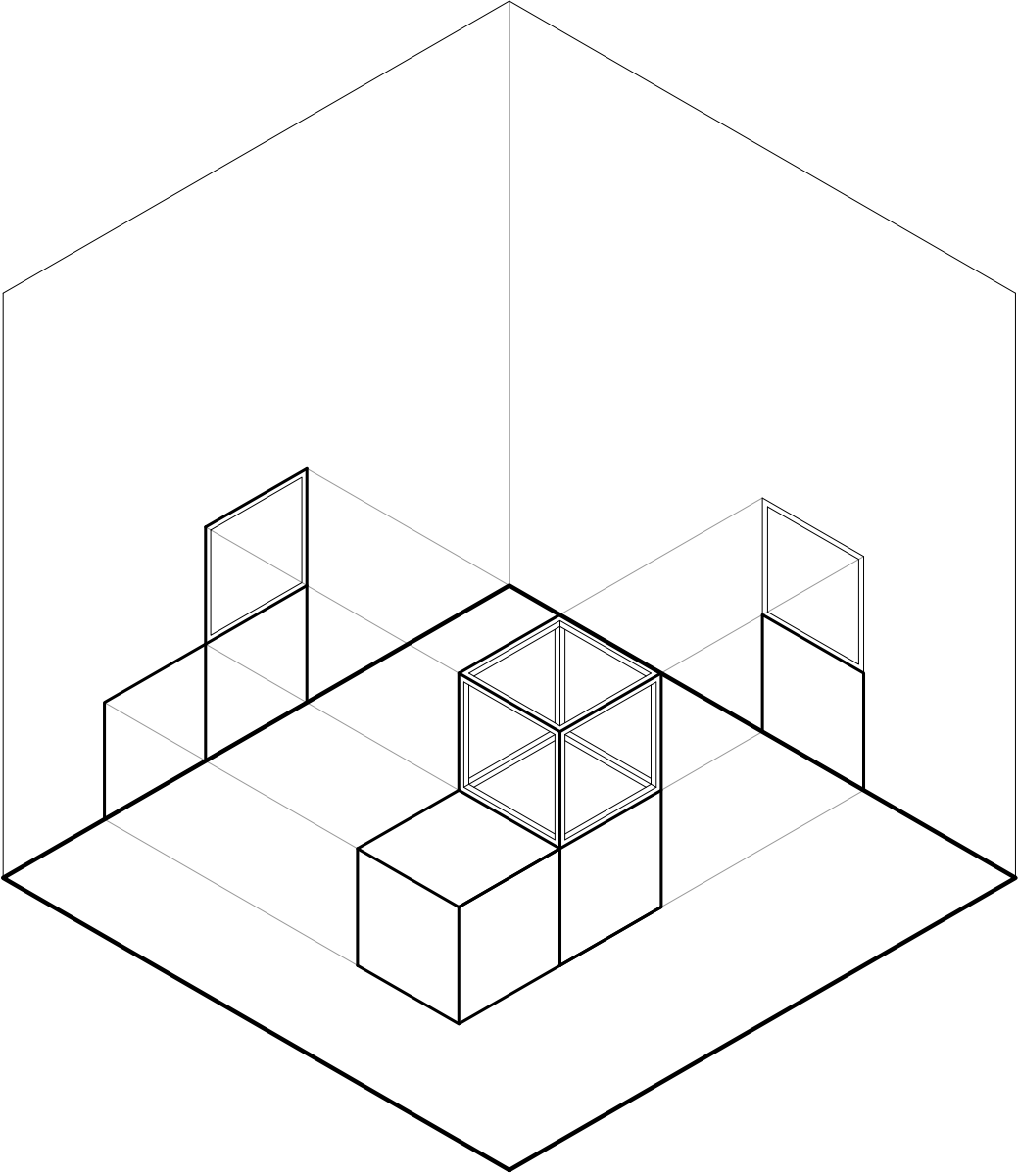

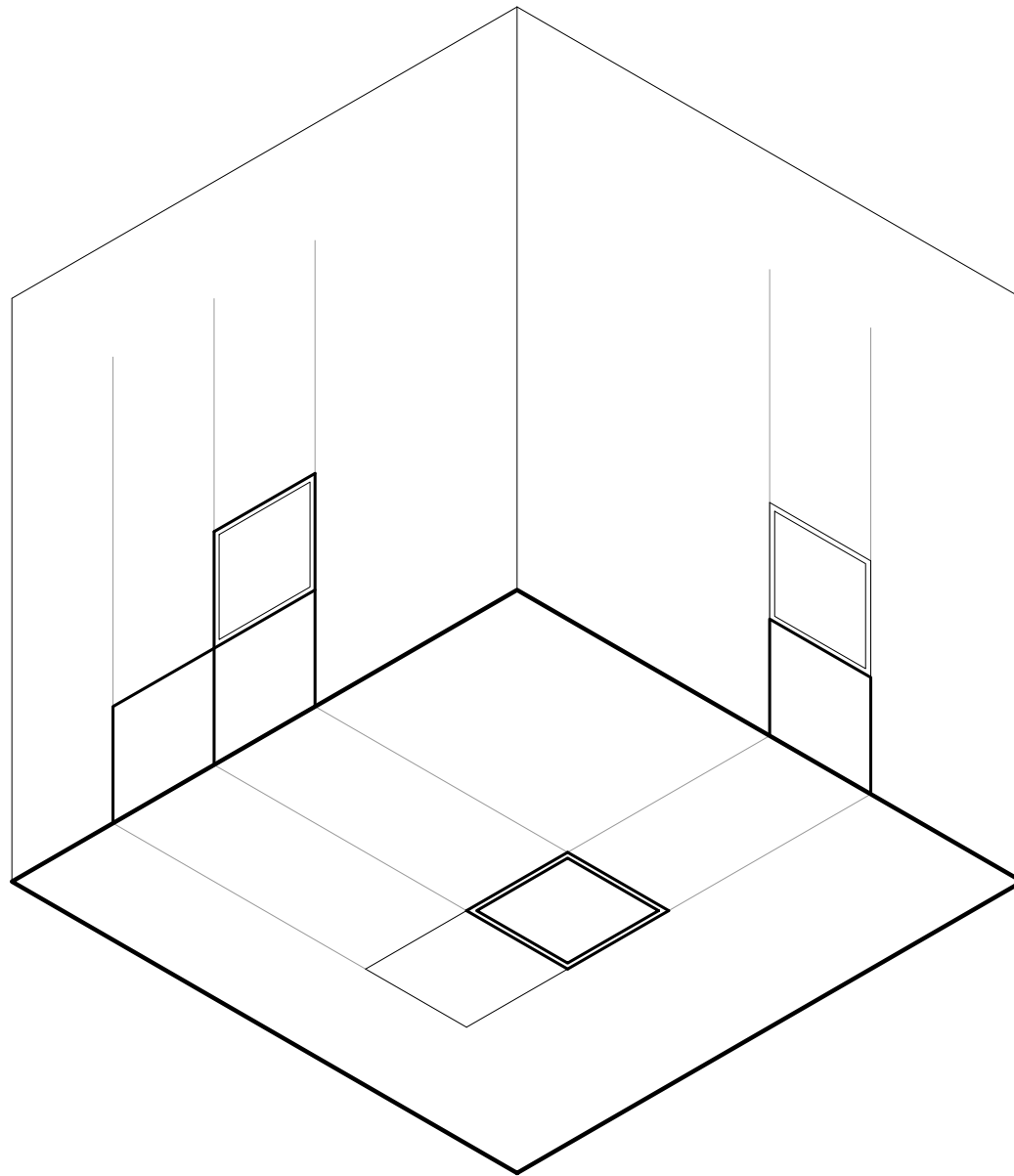

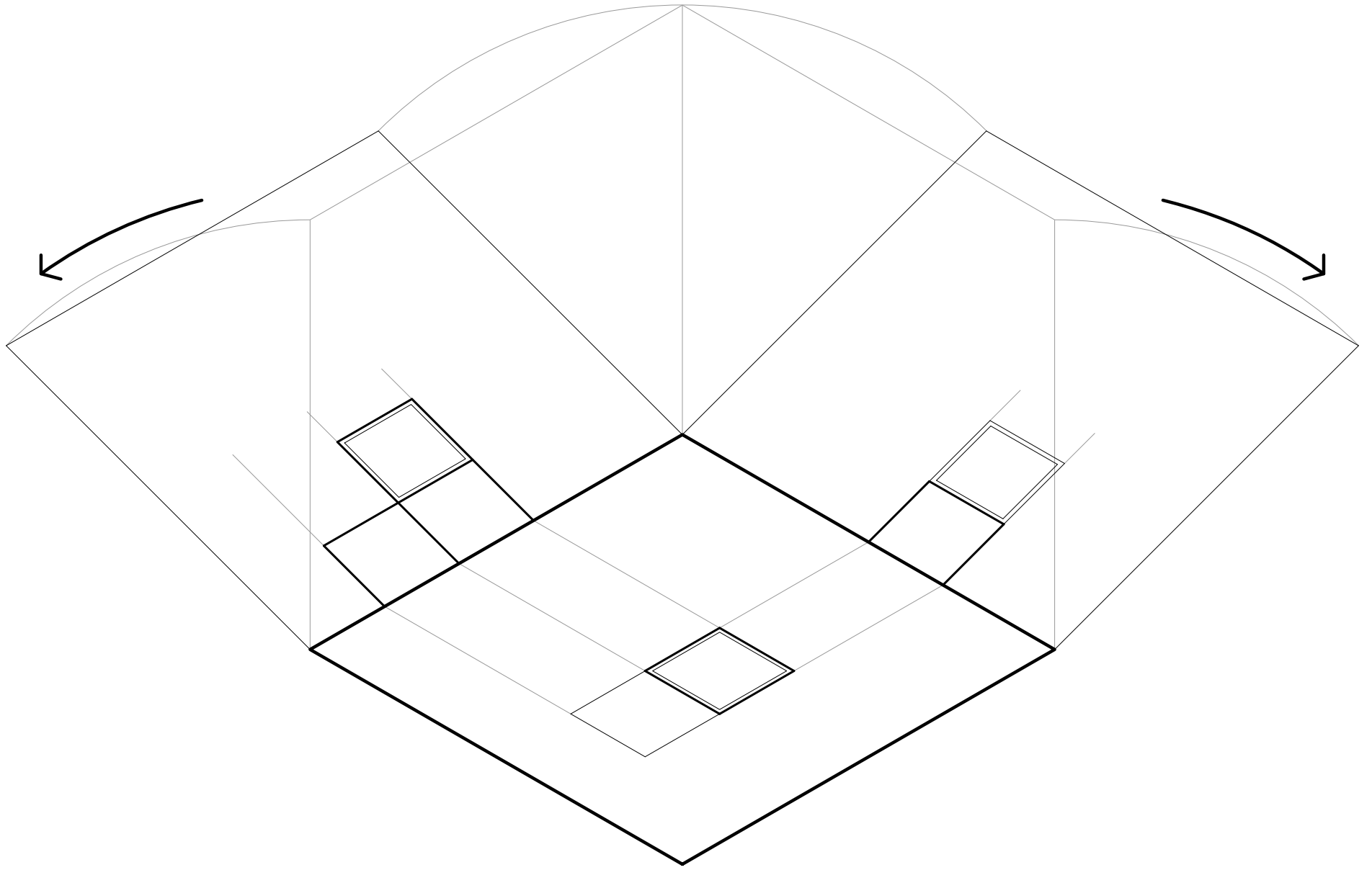

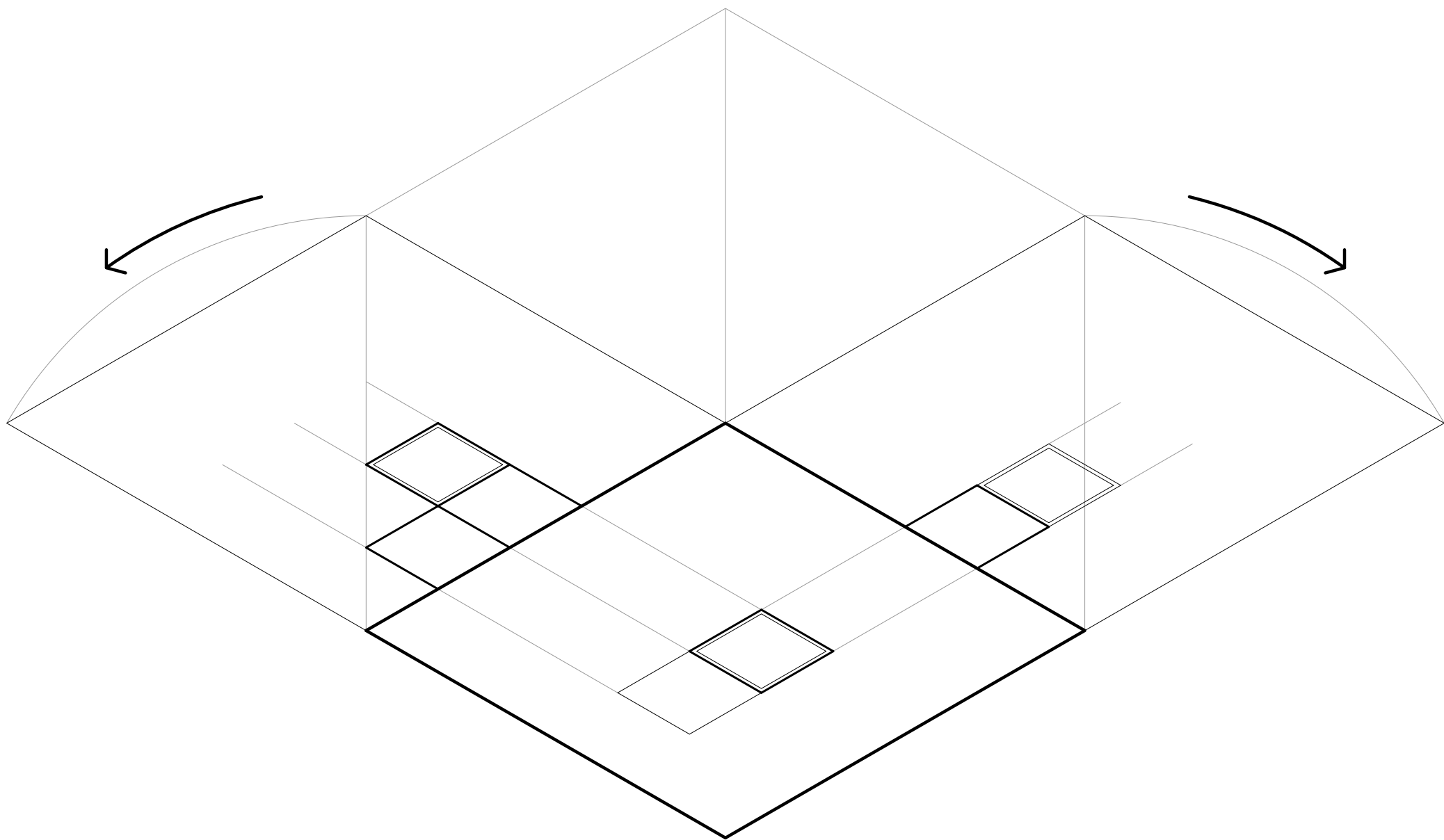

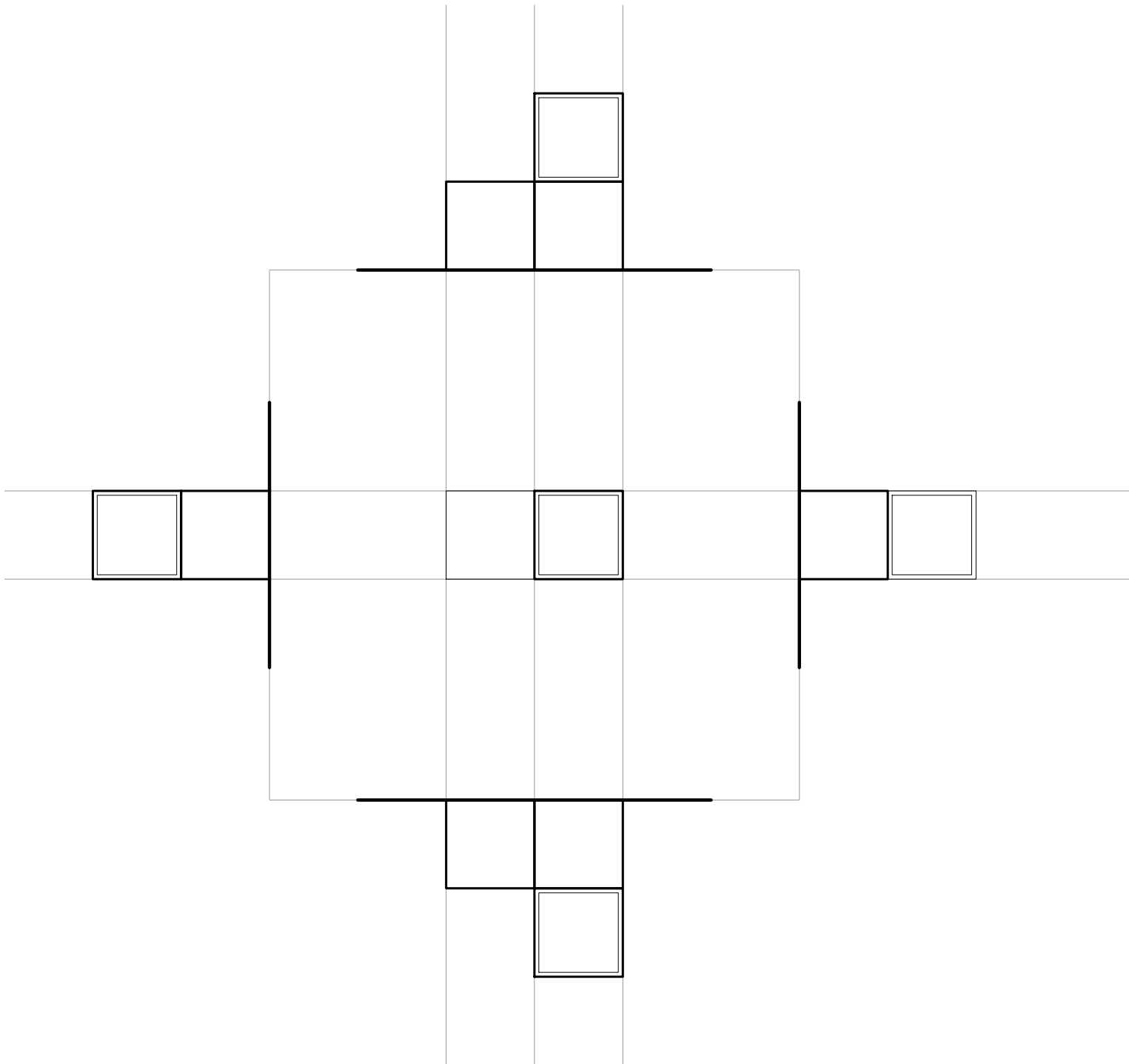

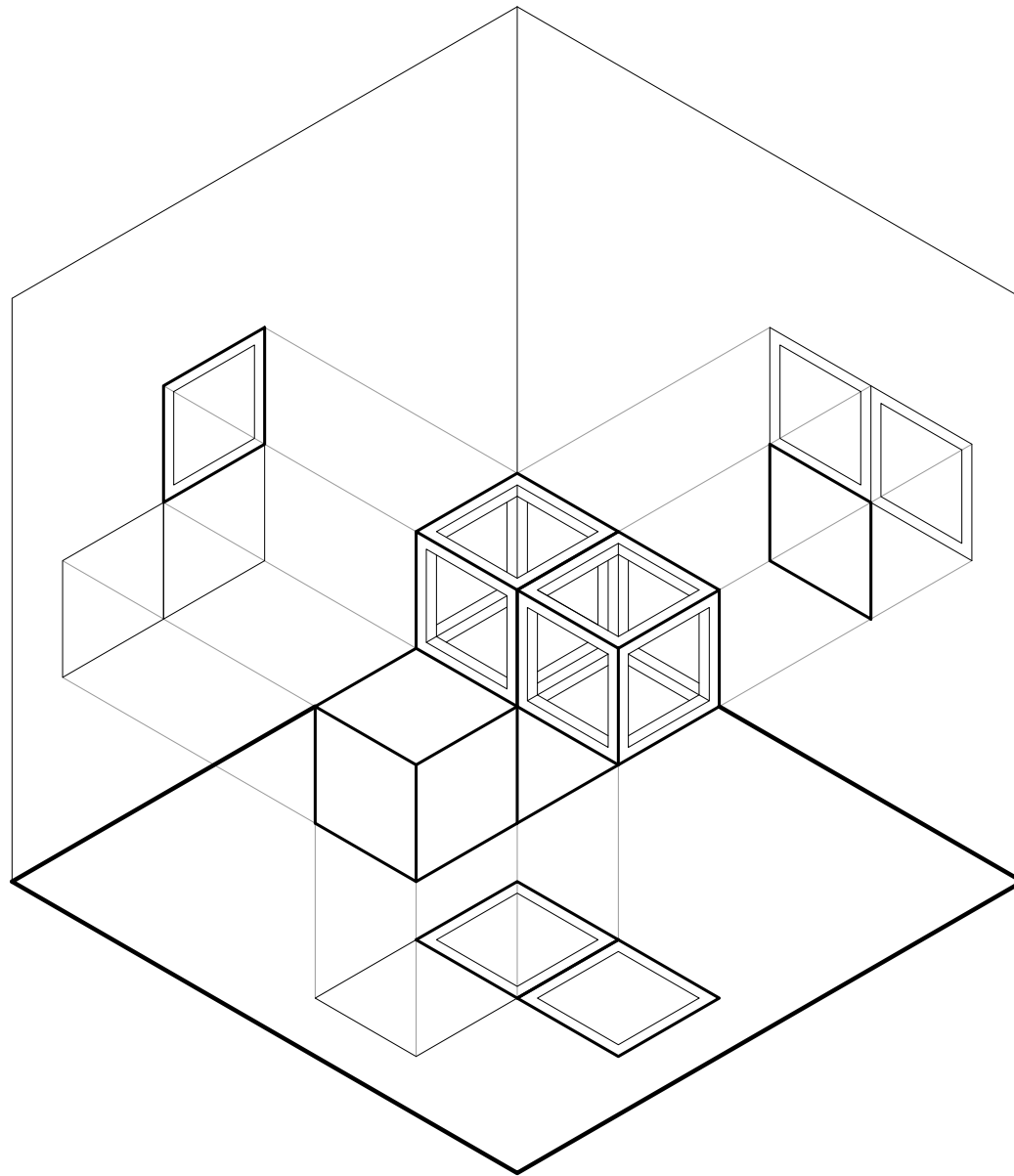

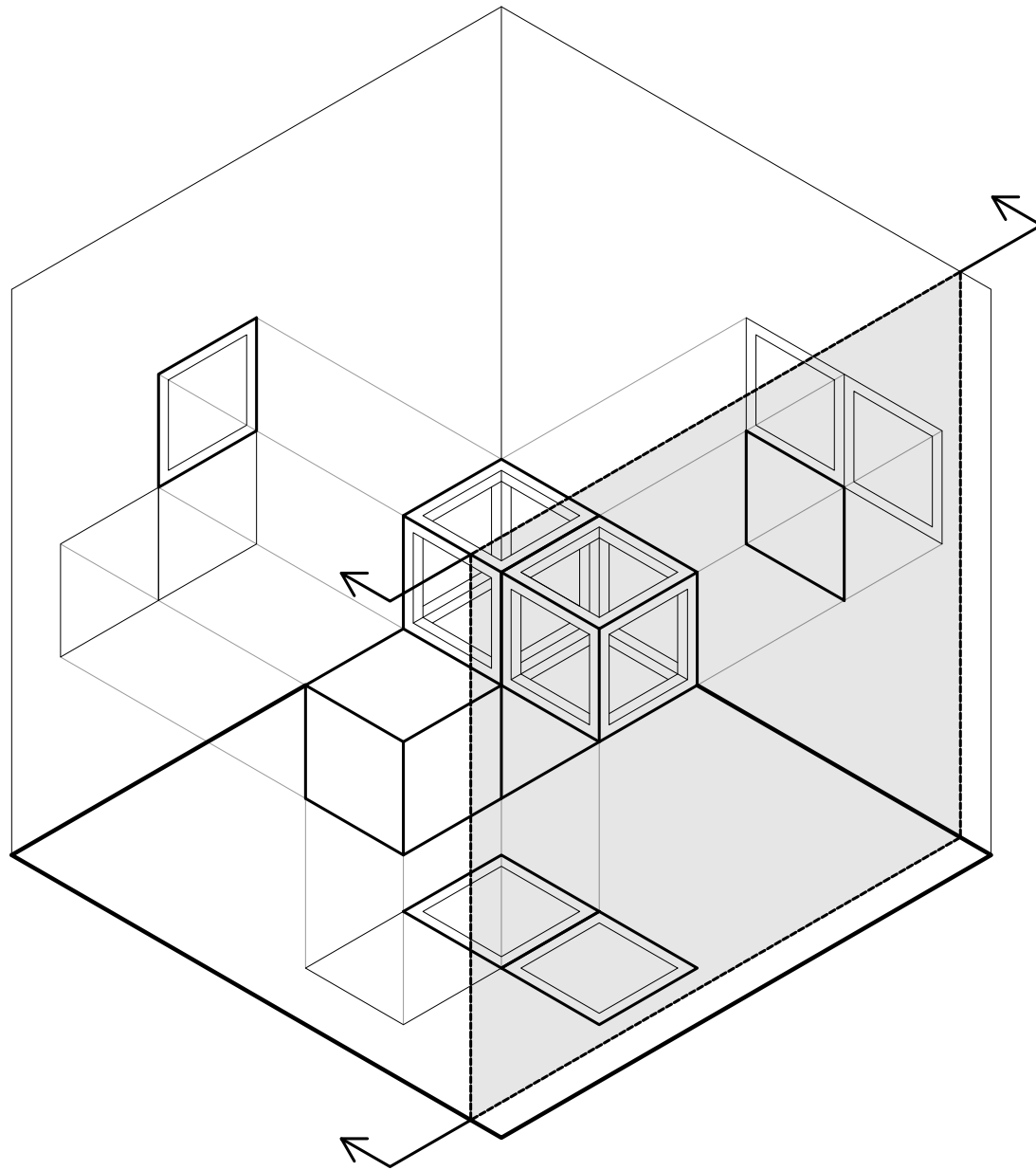

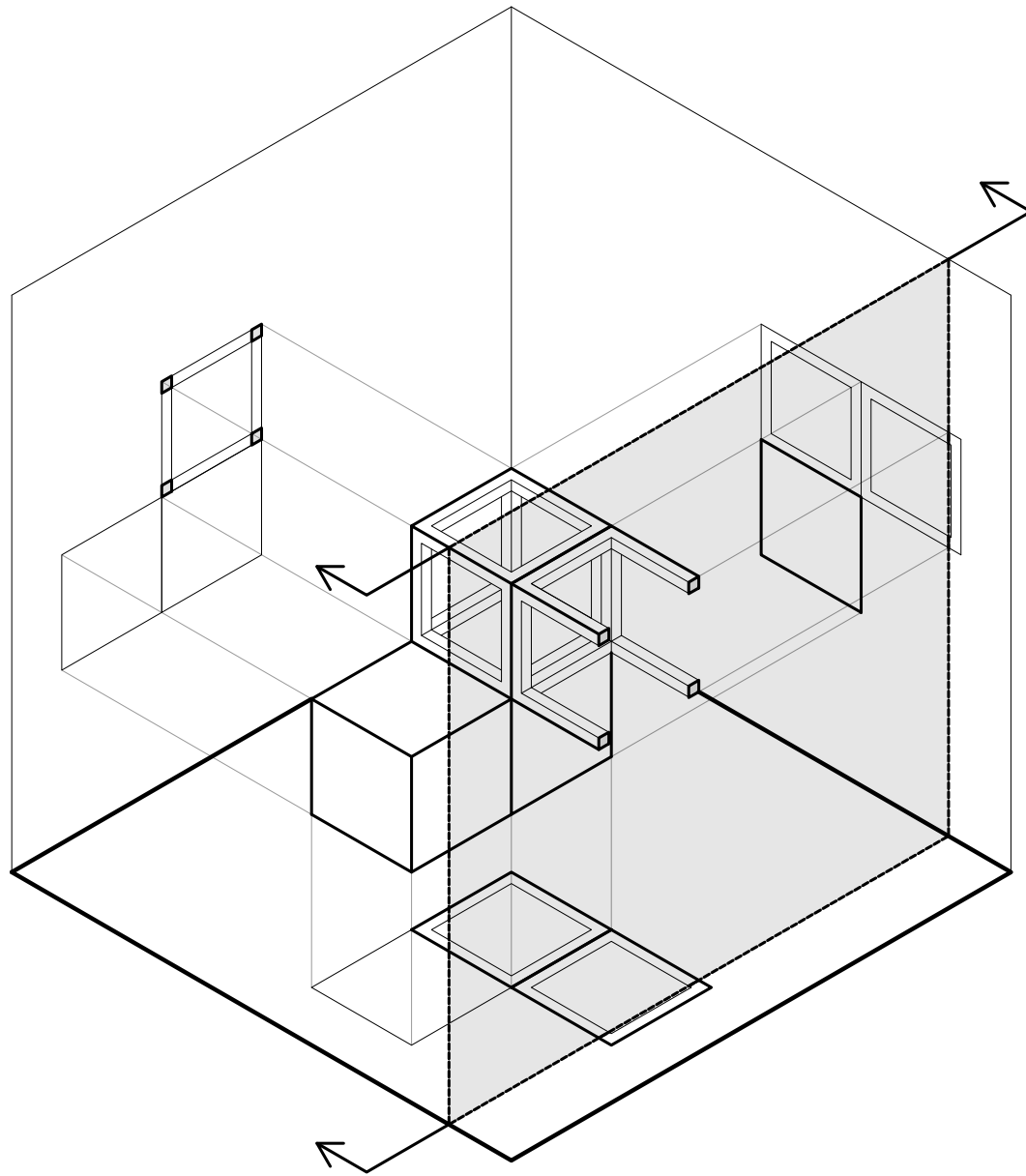

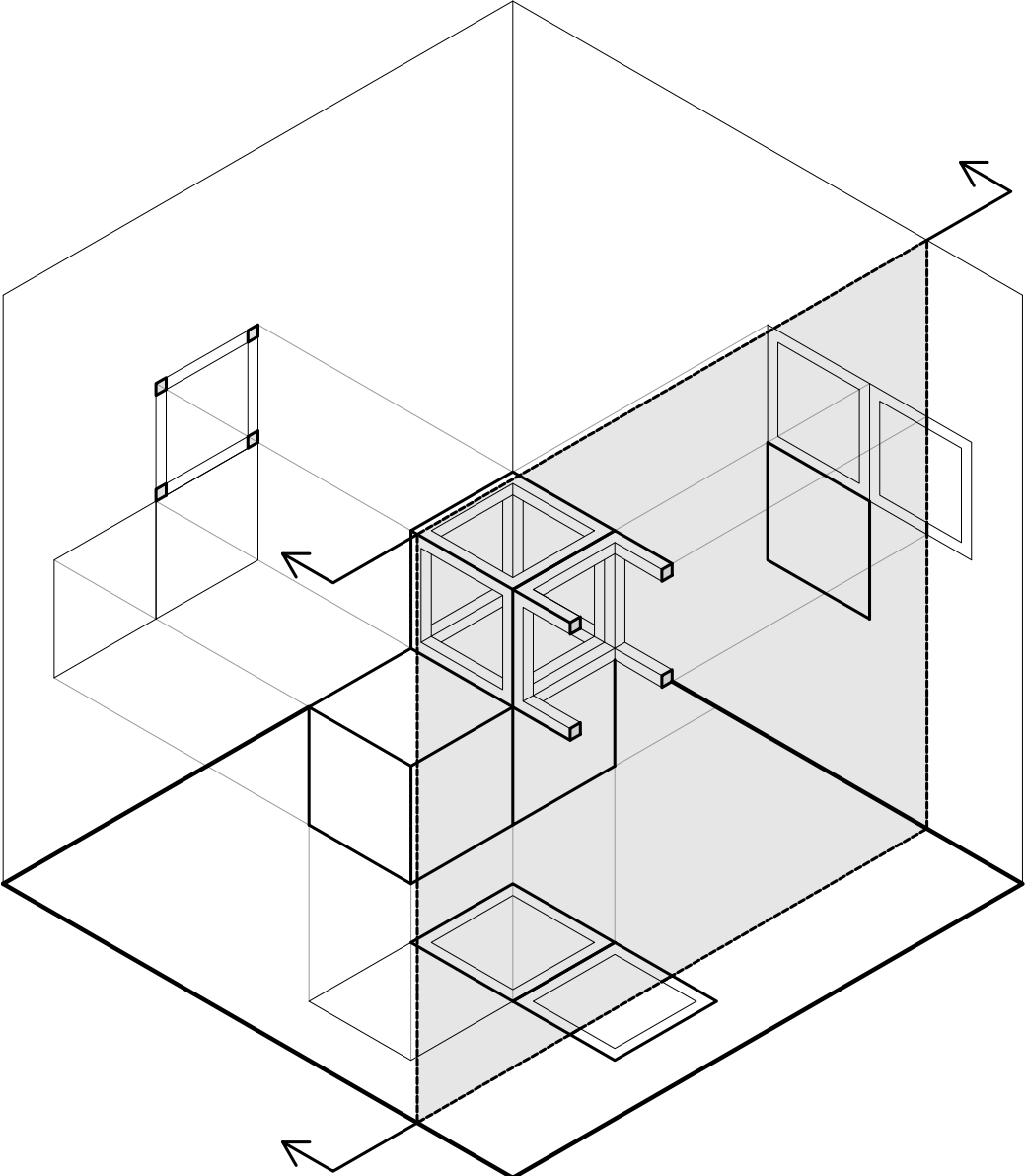

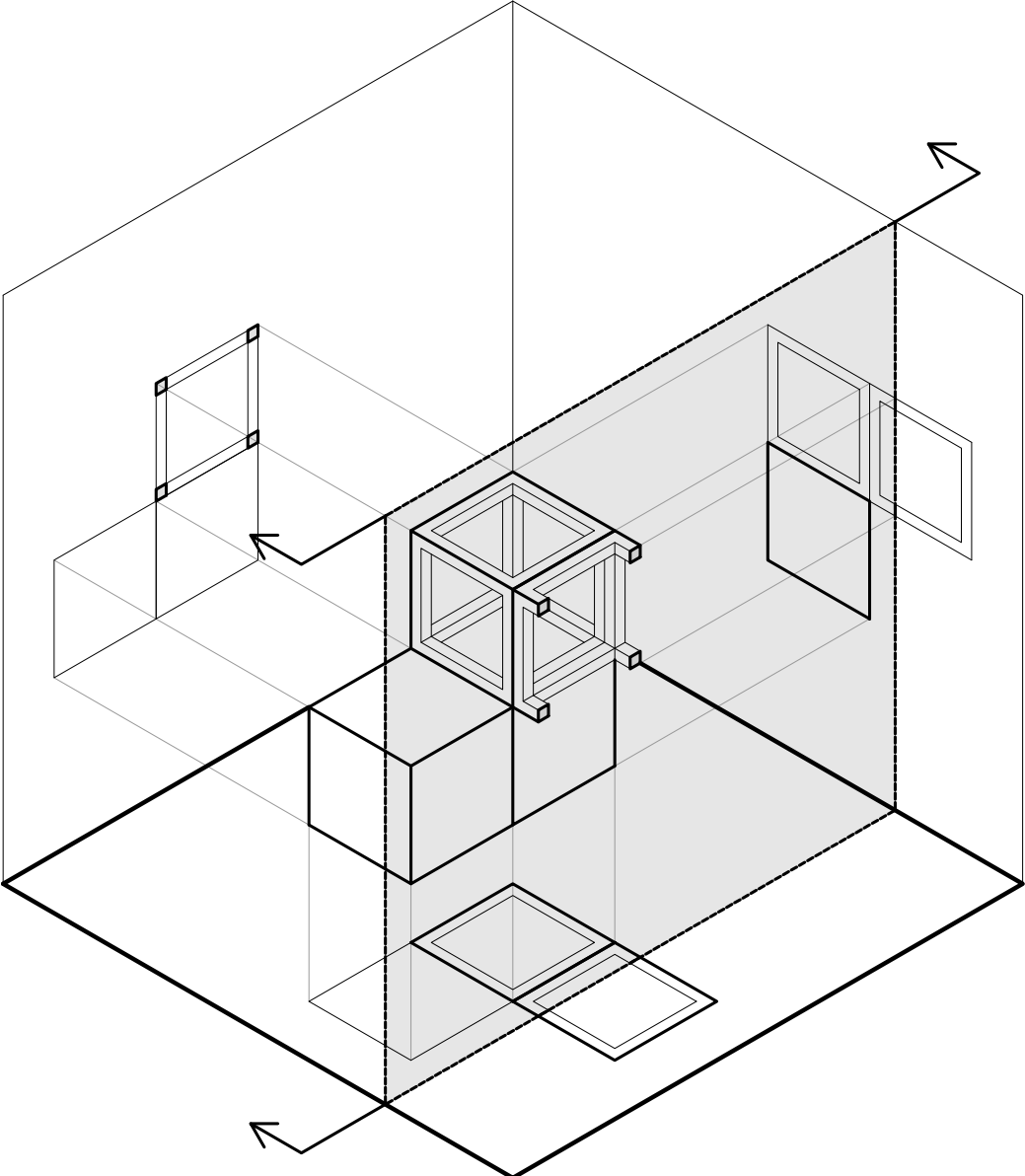

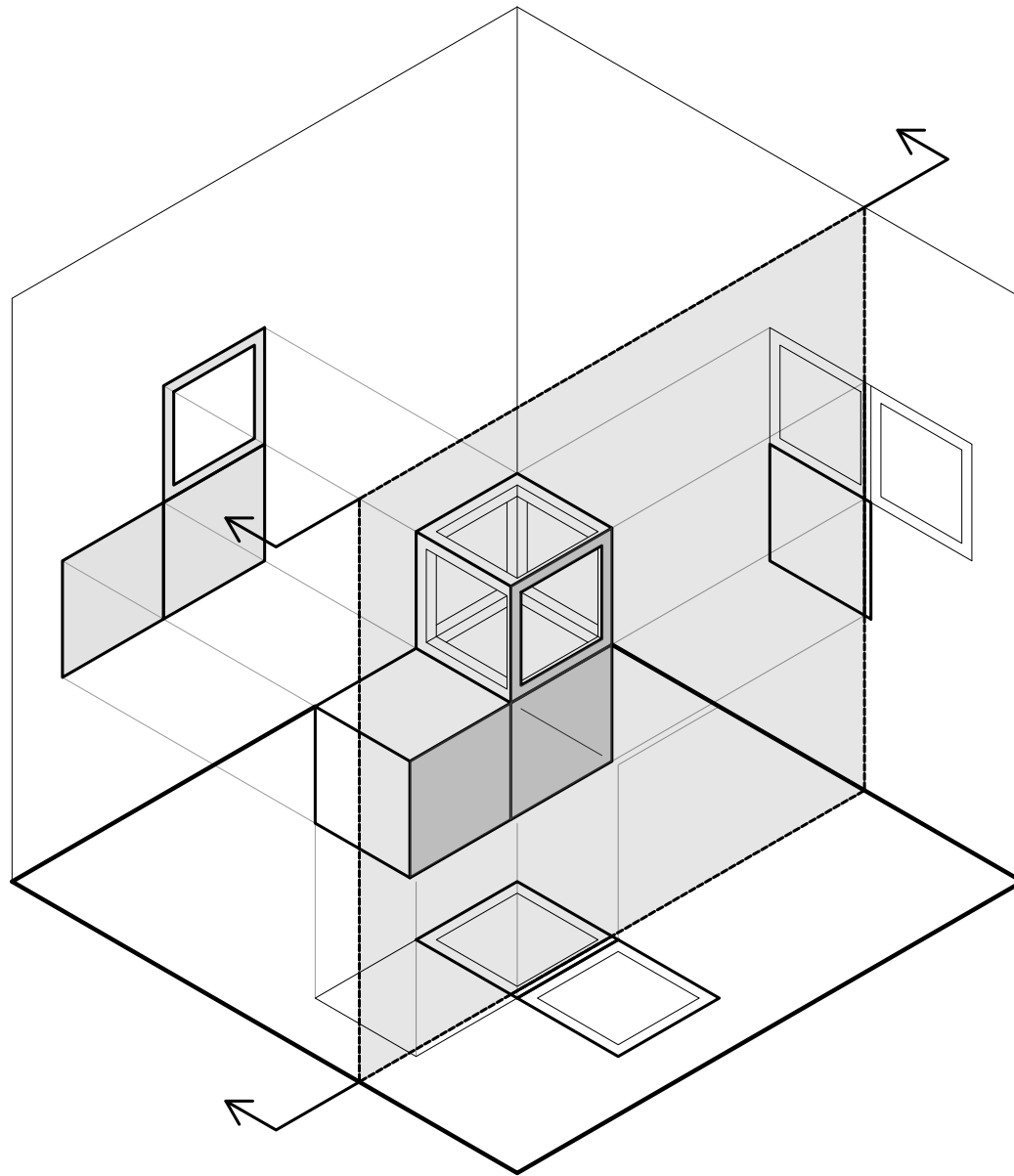

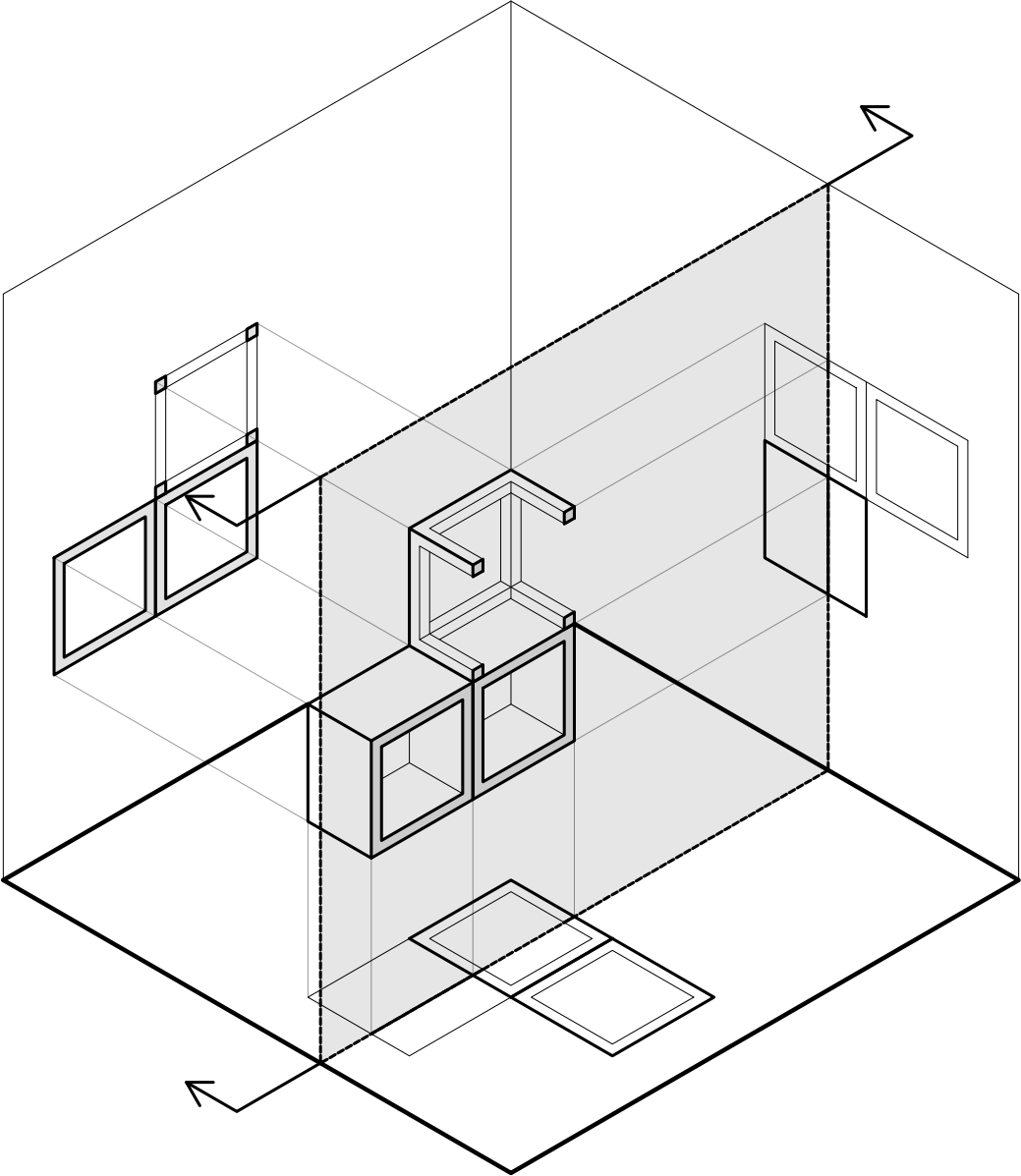

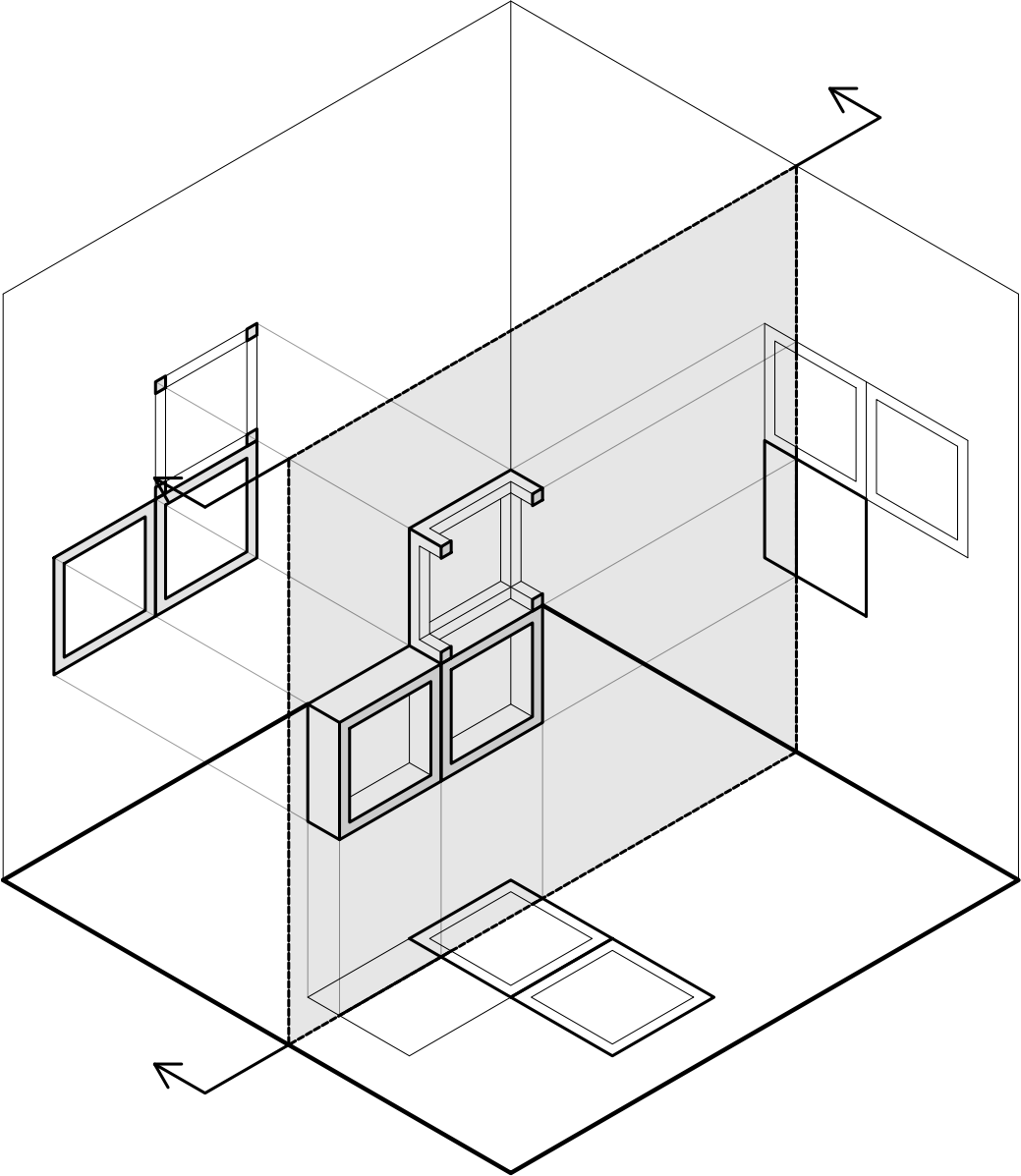

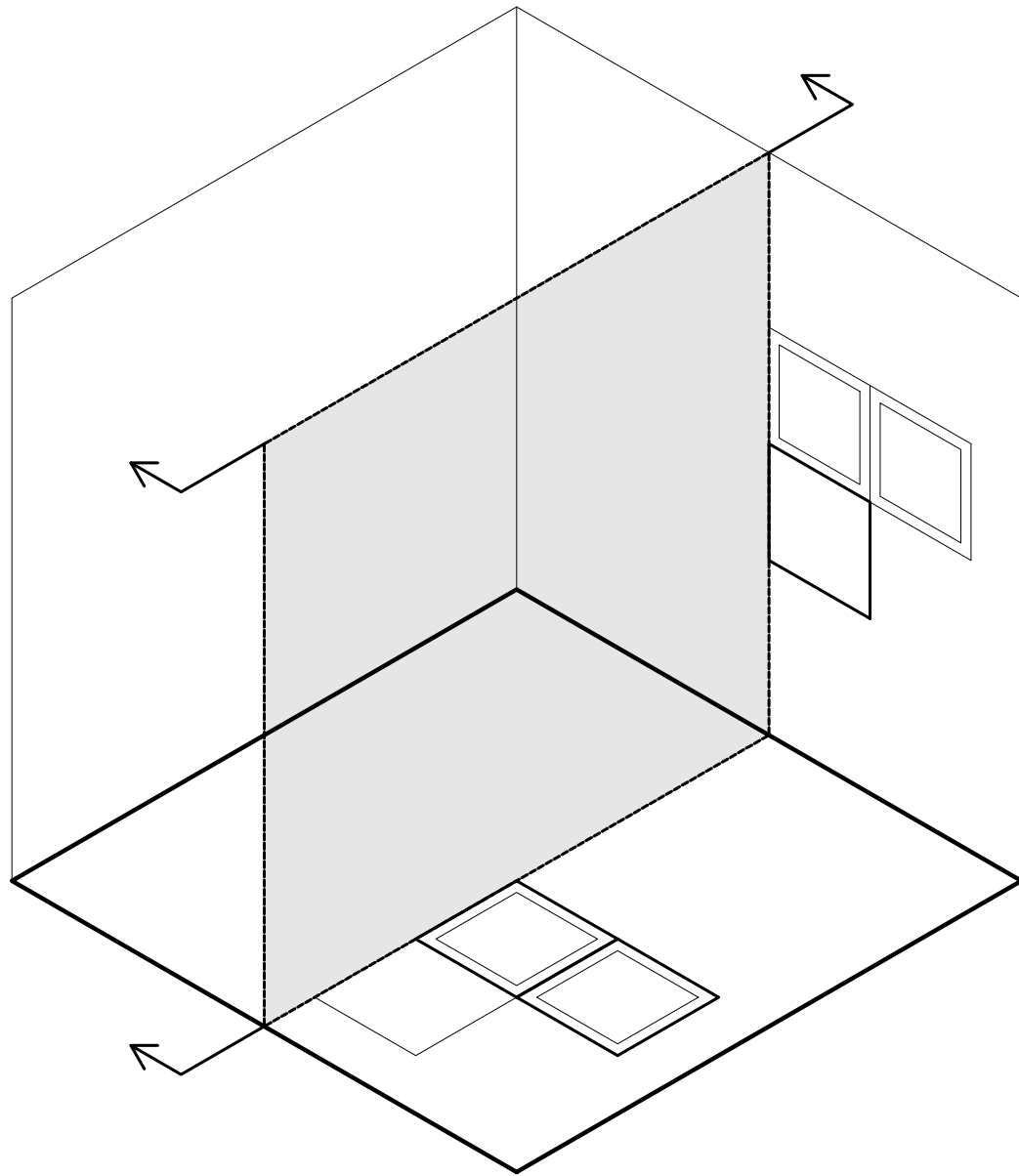

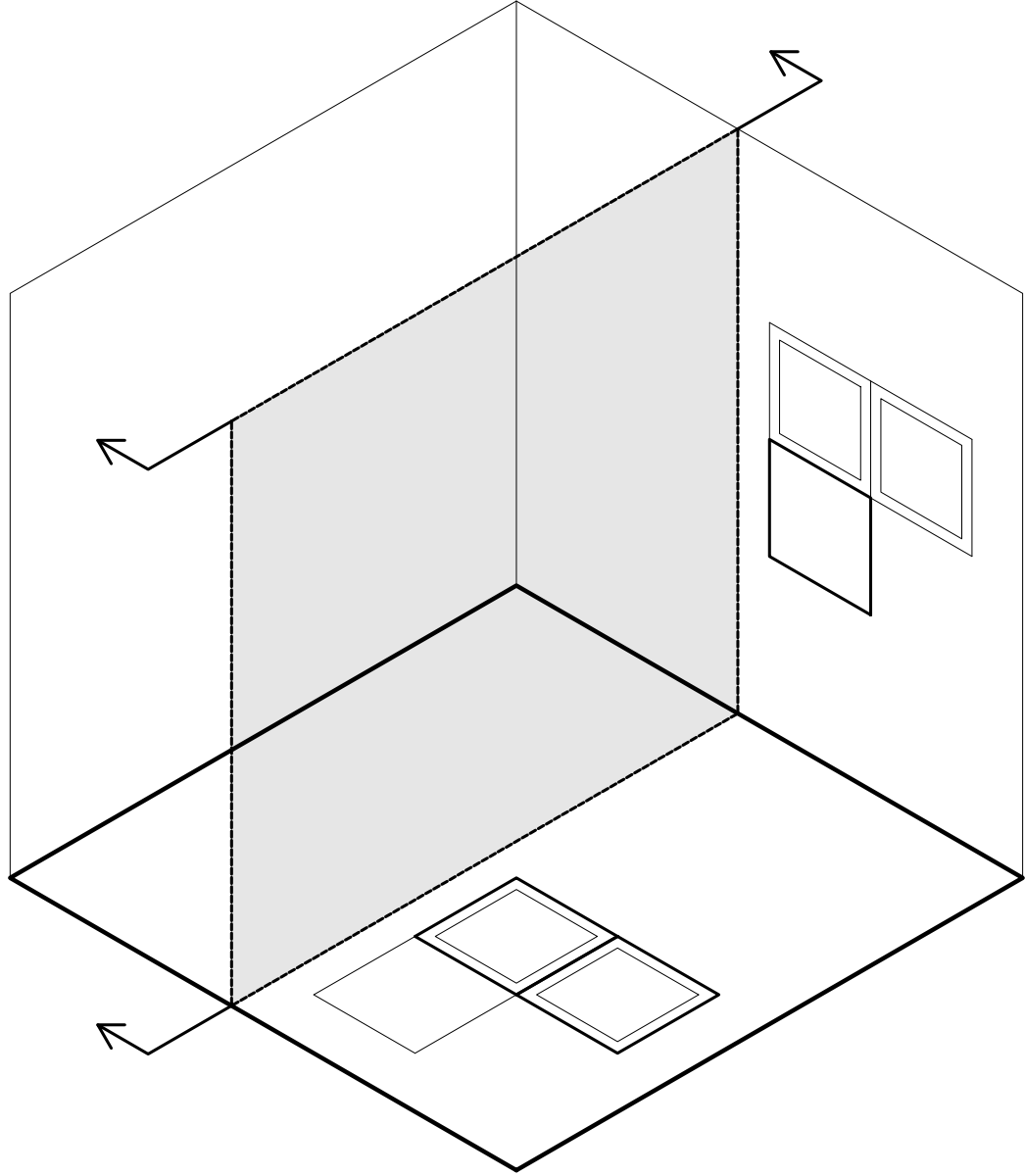

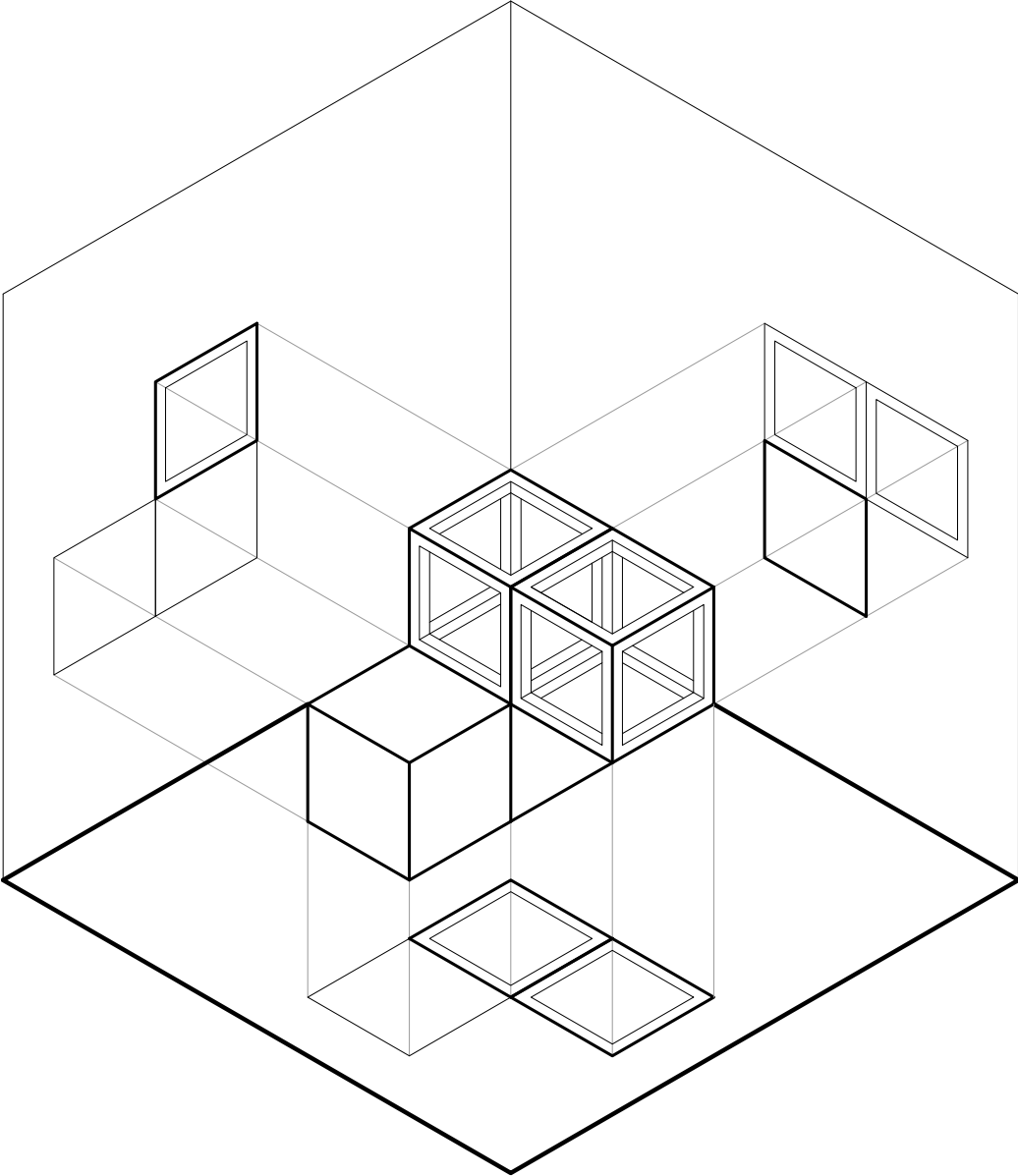

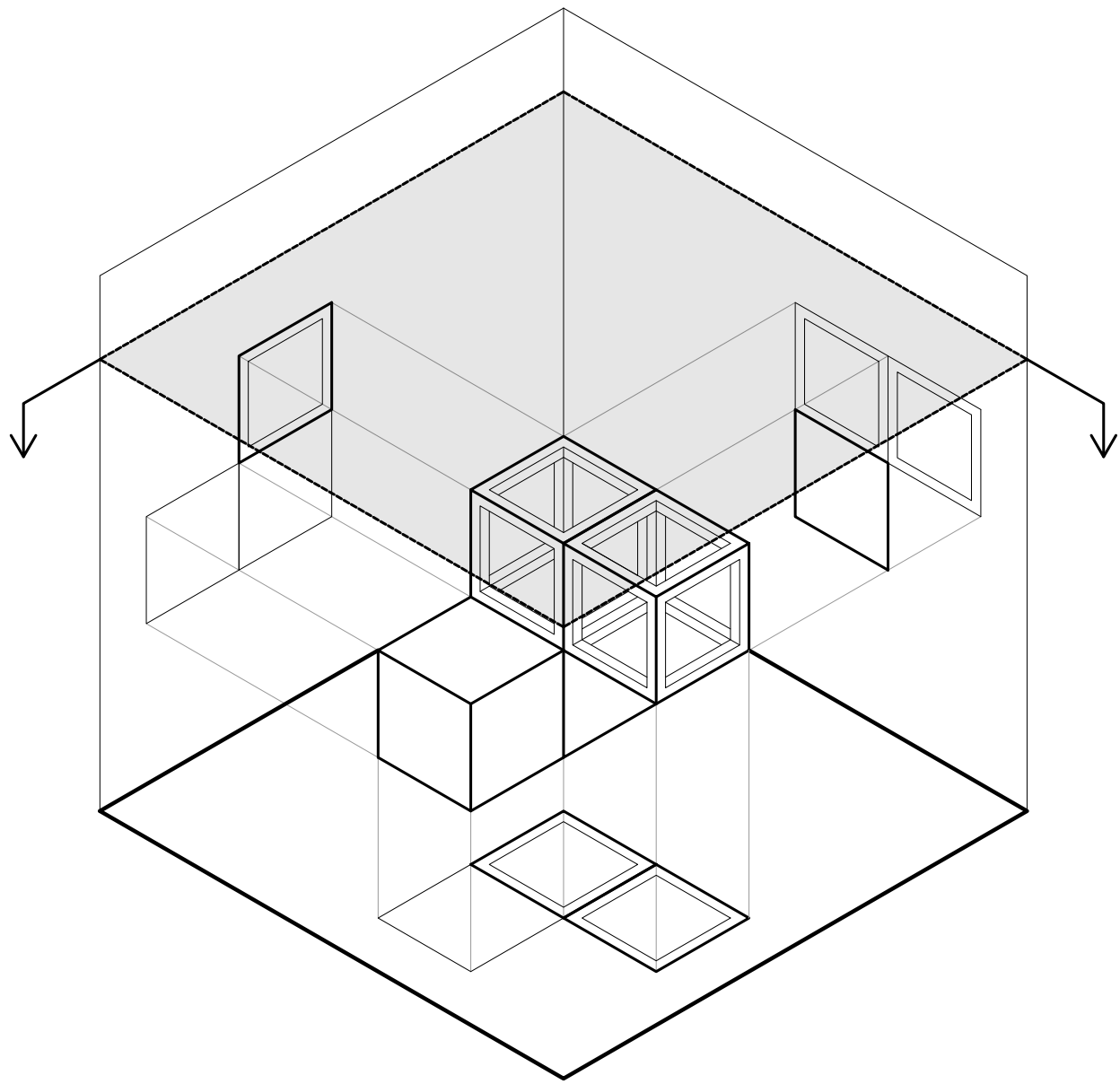

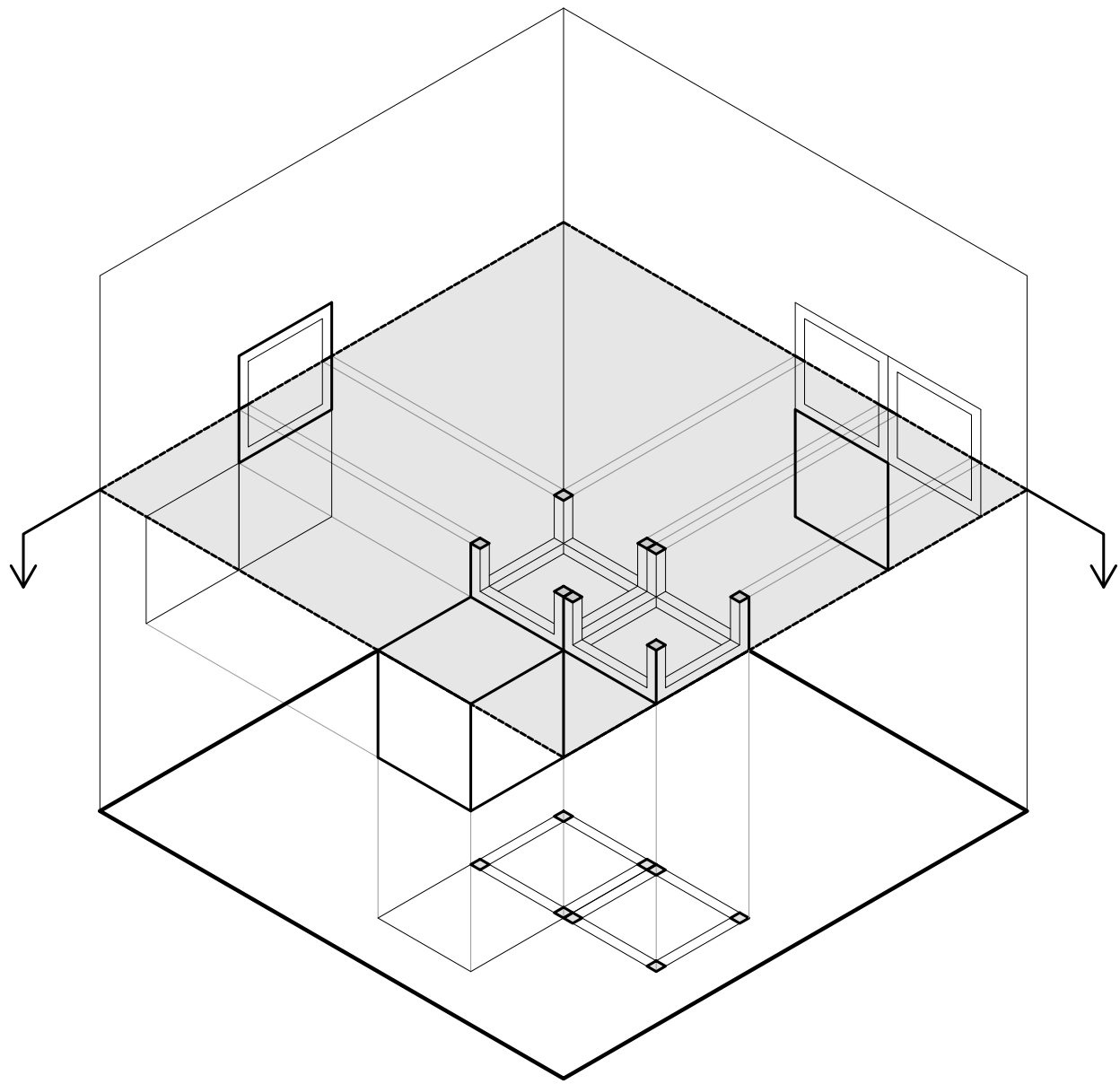

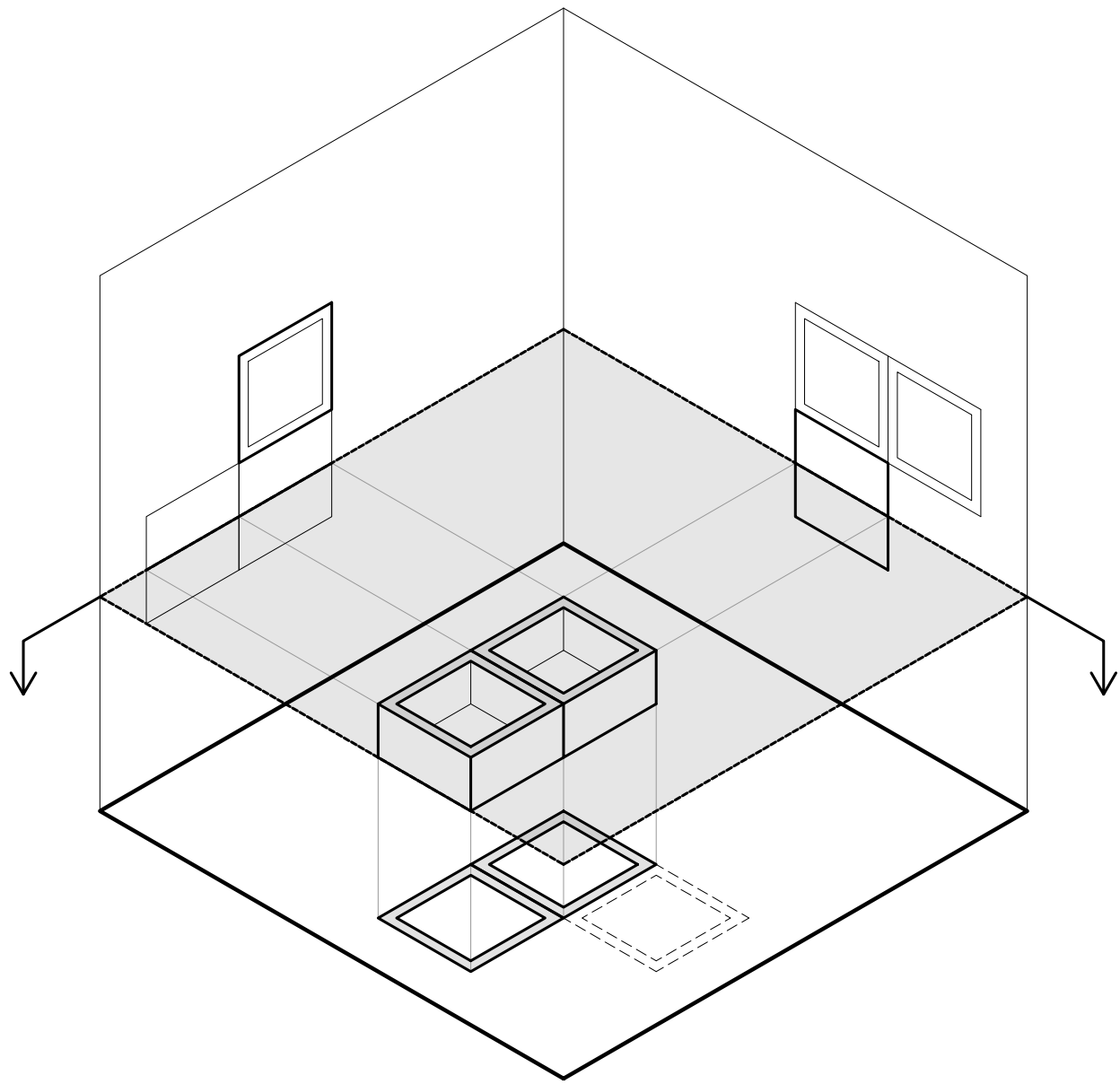

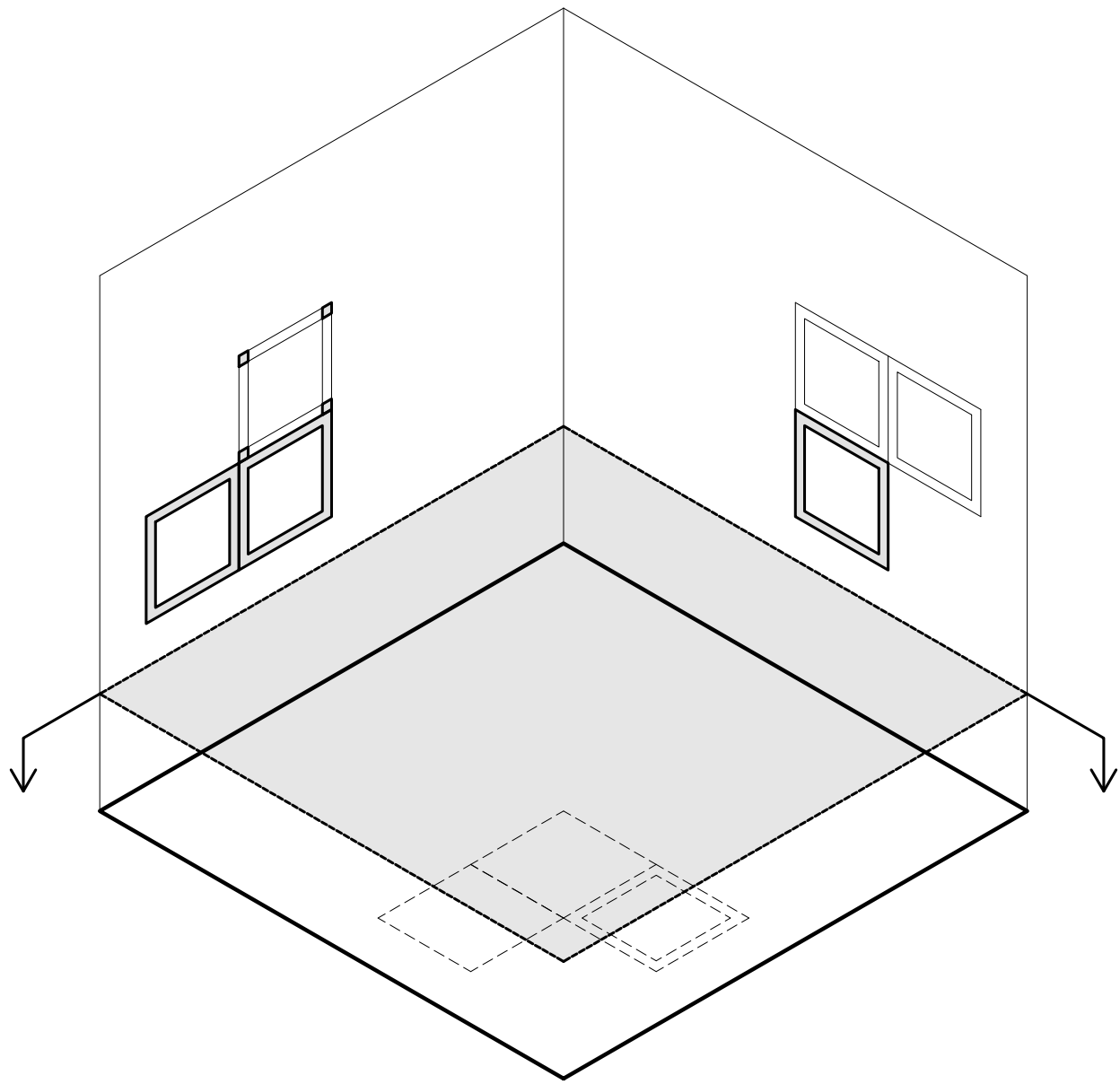

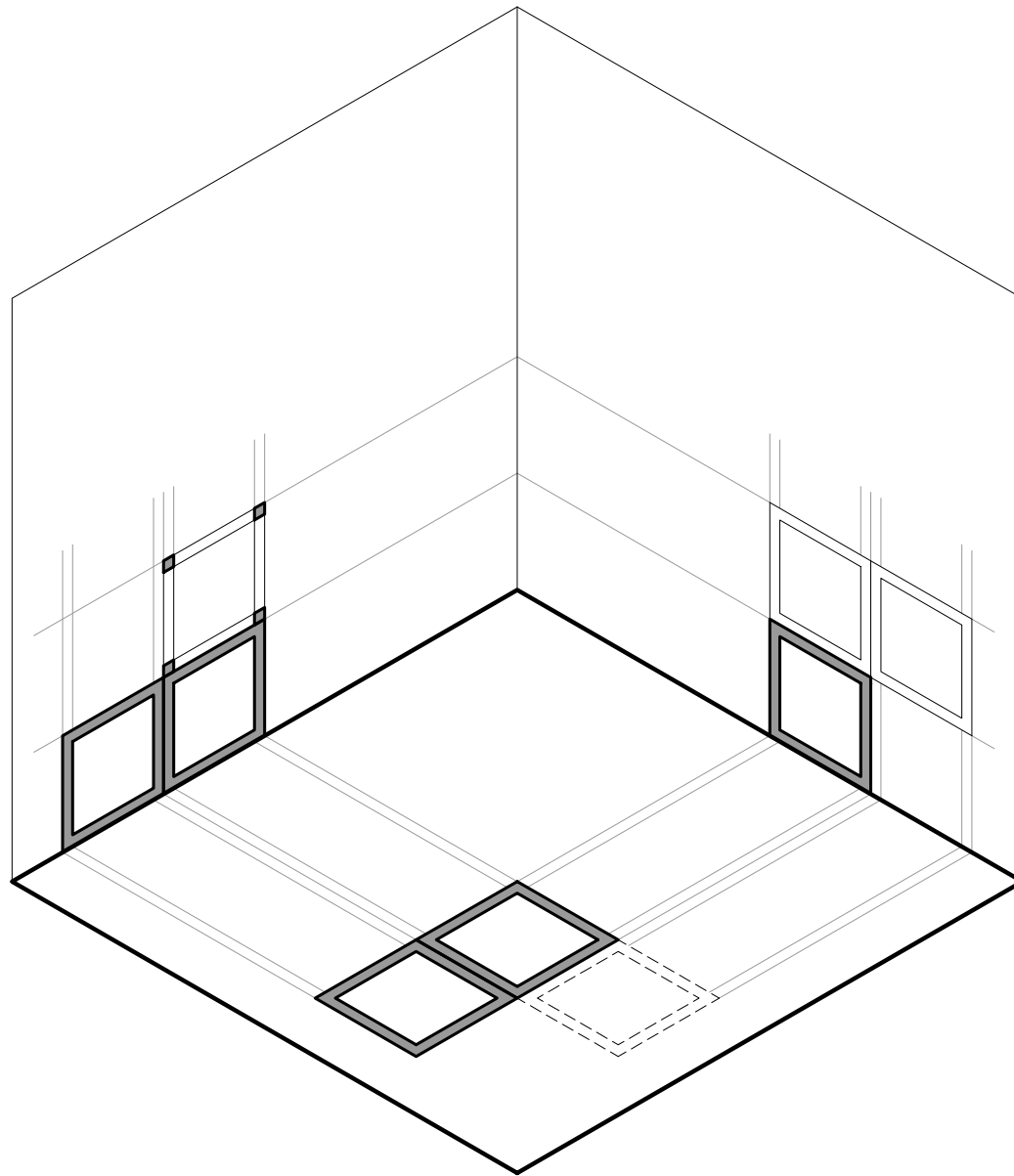

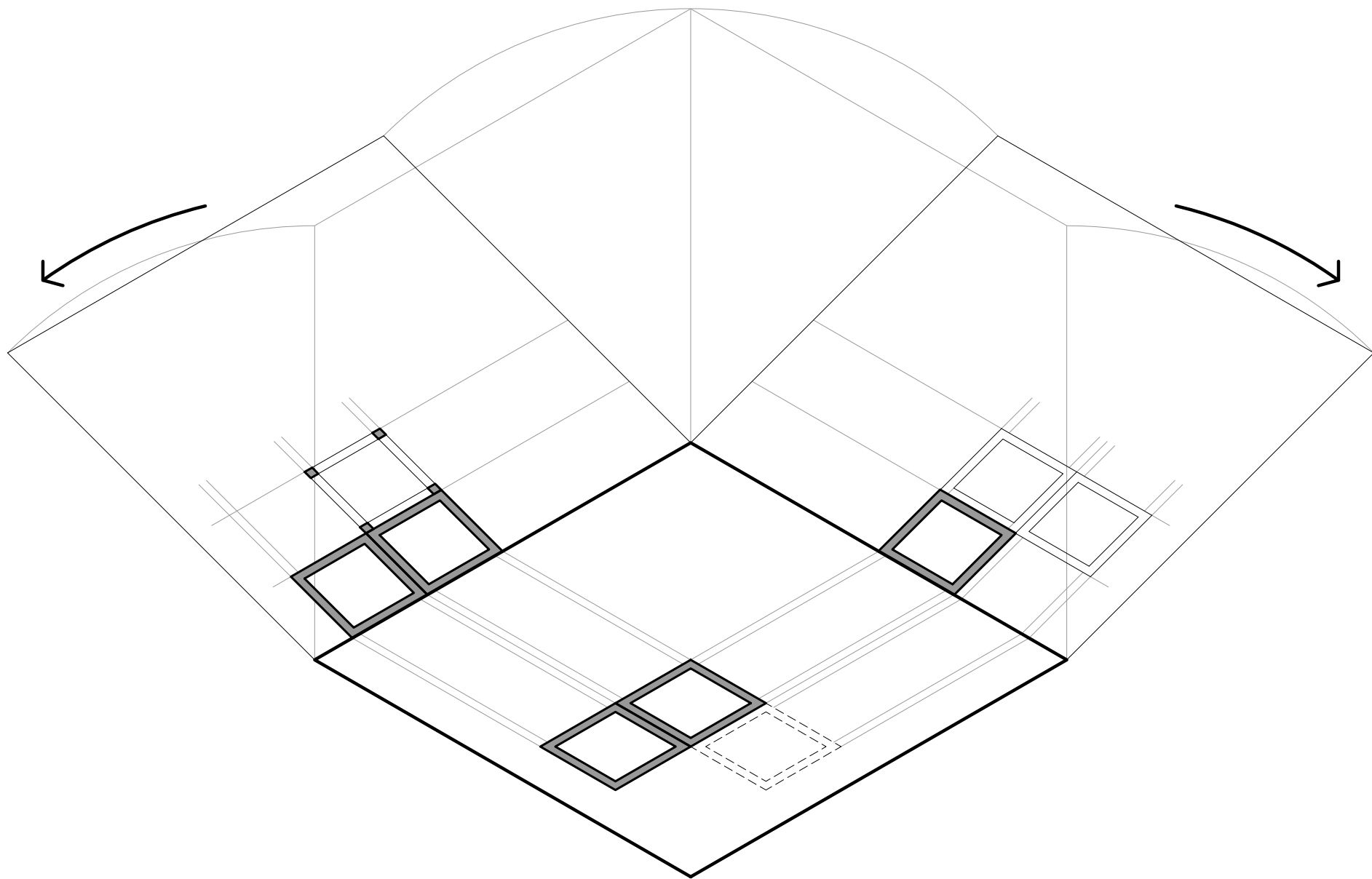

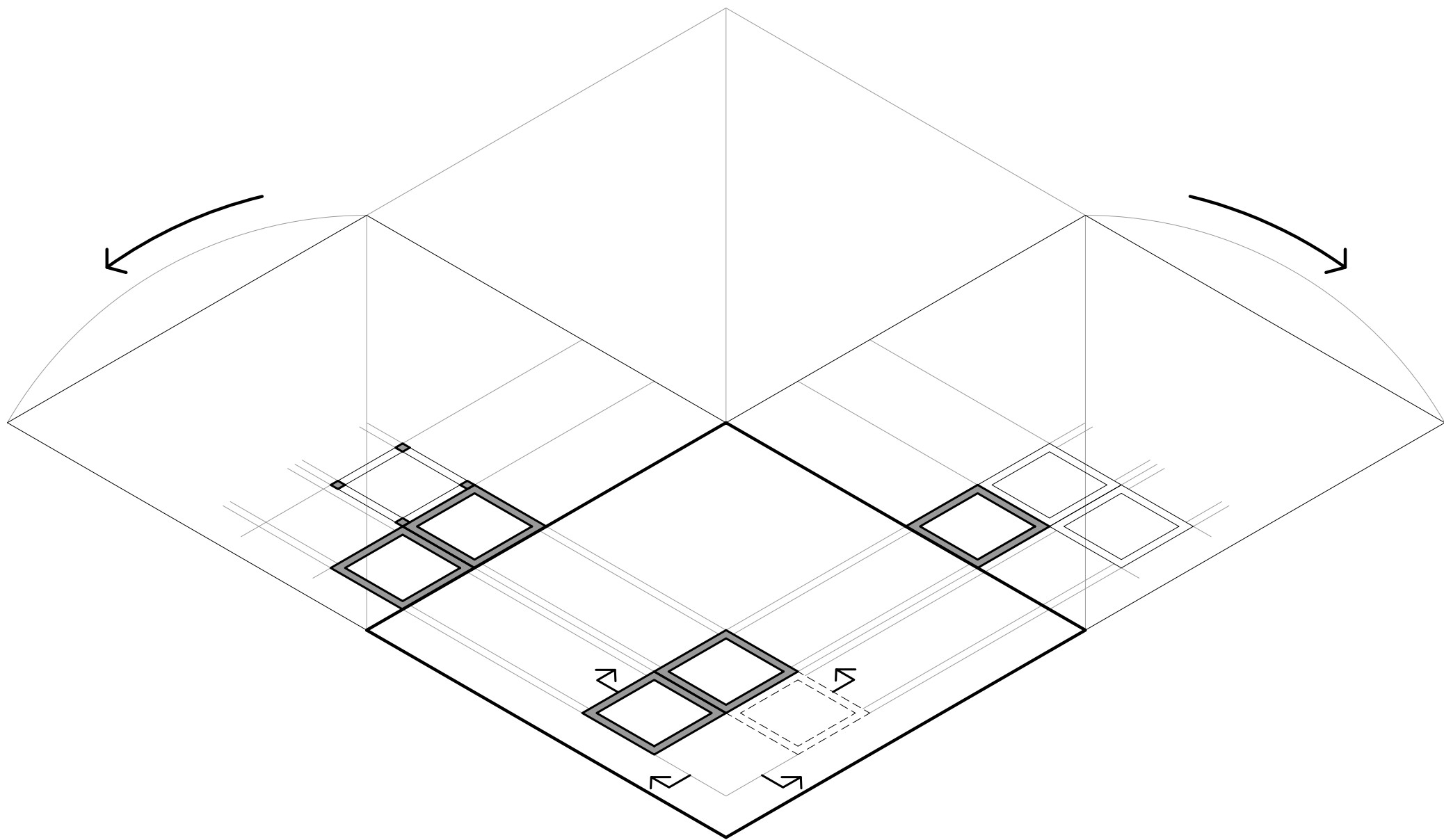

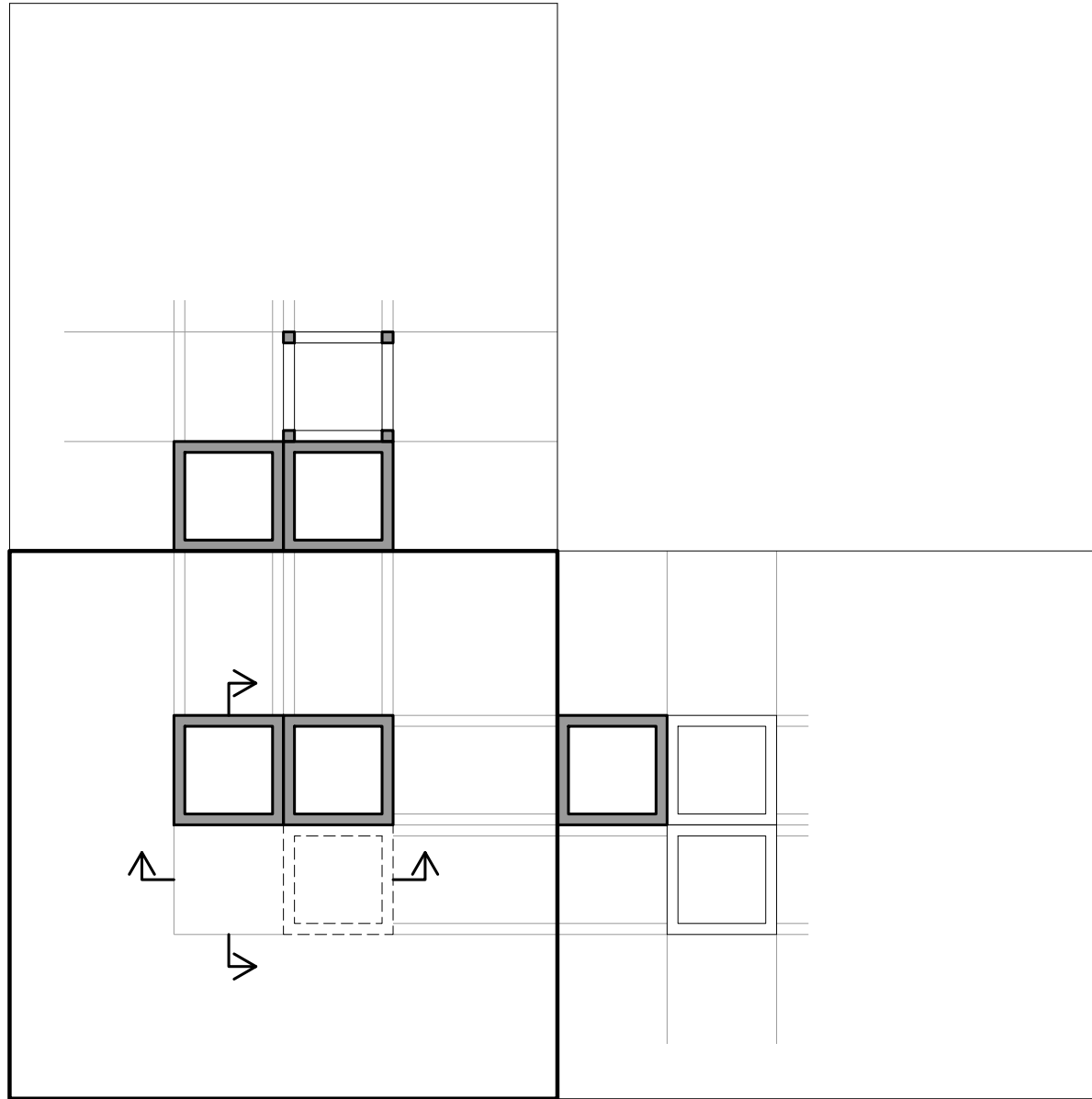

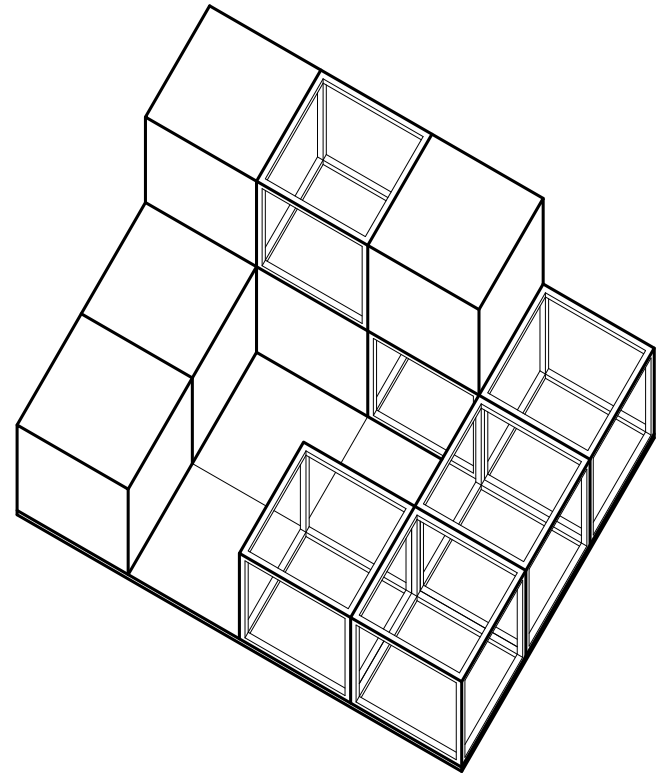

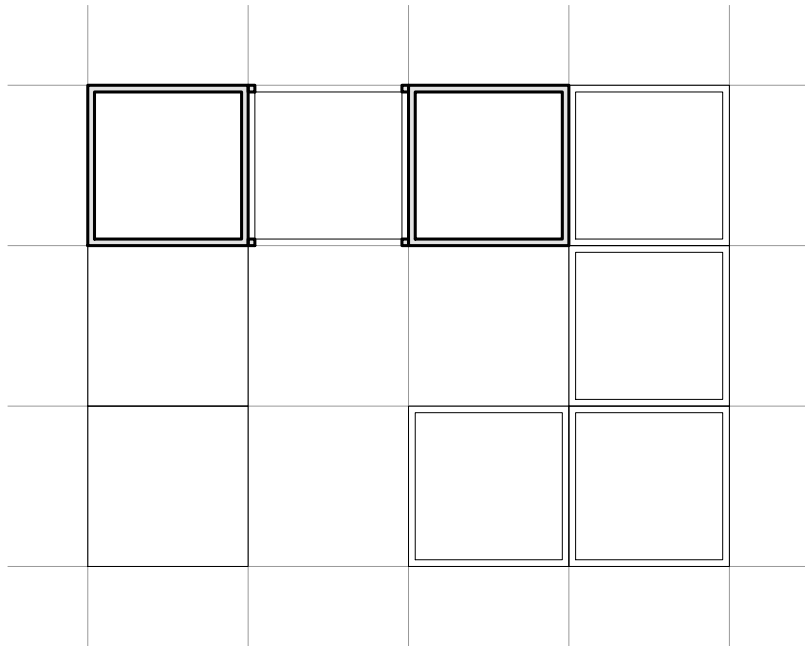
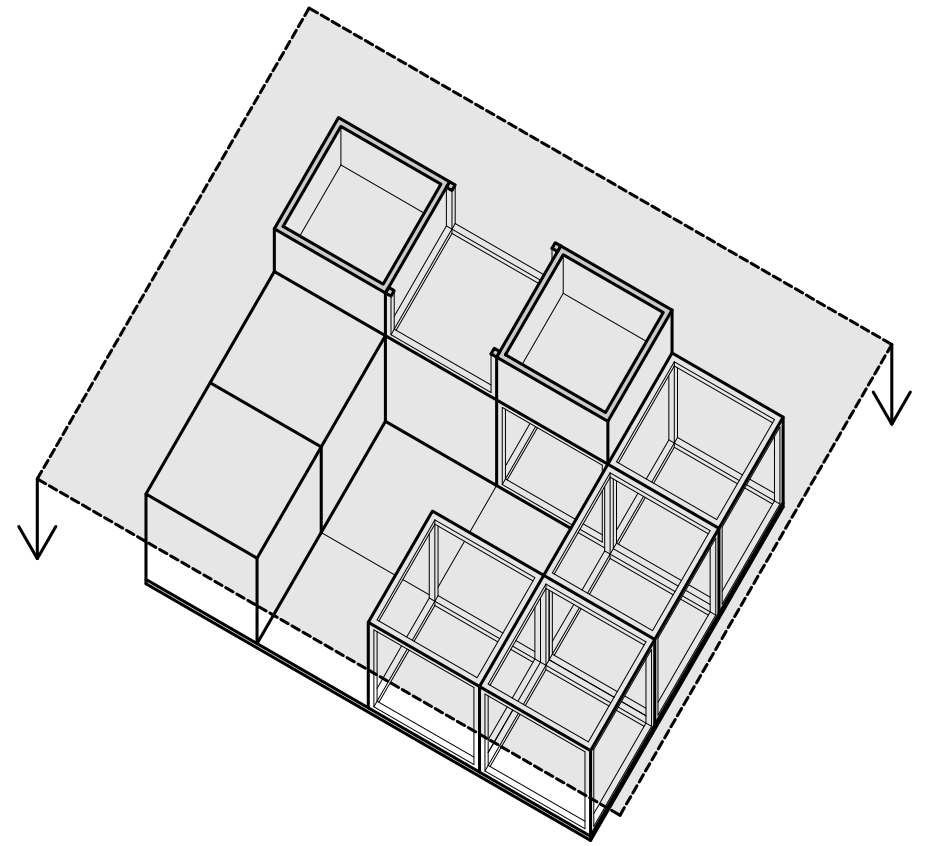

PLANTA NIVEL 1

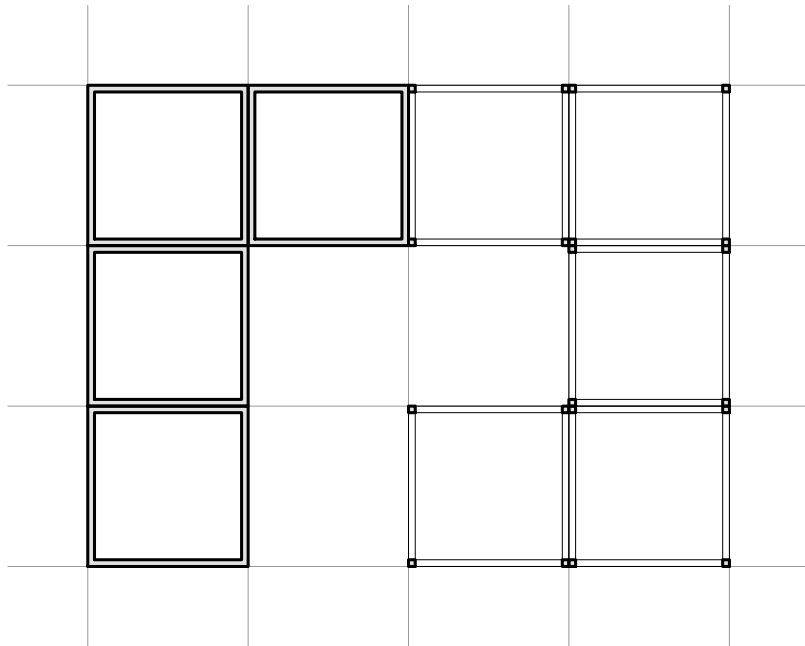
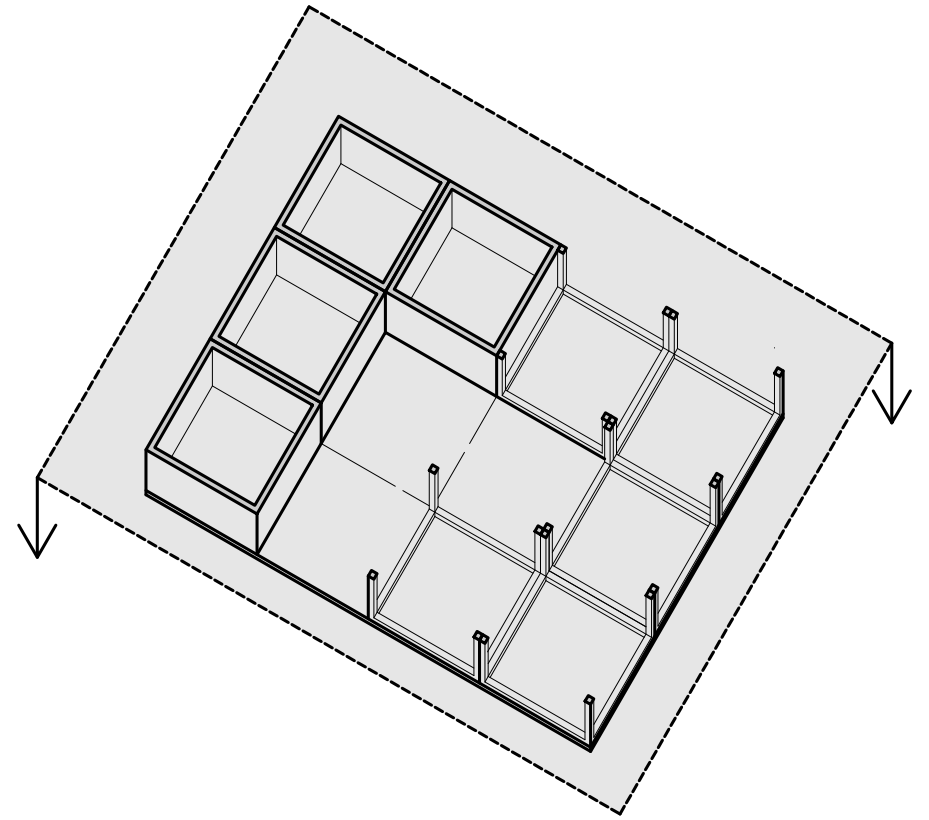

PLANTA NIVEL 0

- CORTE
- SECCIÓN

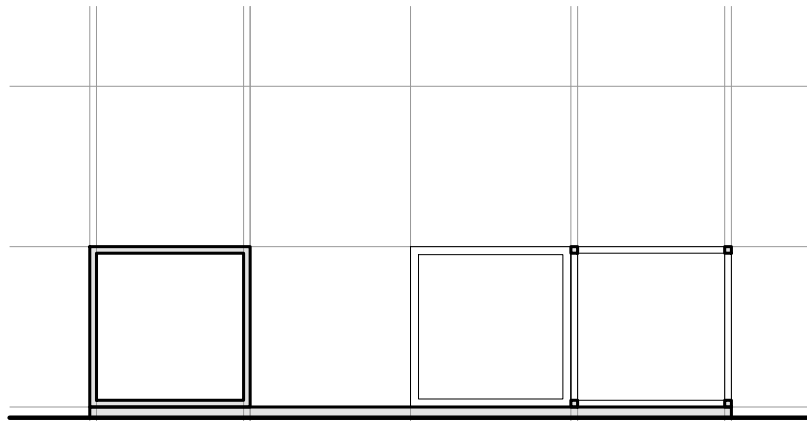

CORTE A-A
Transversal

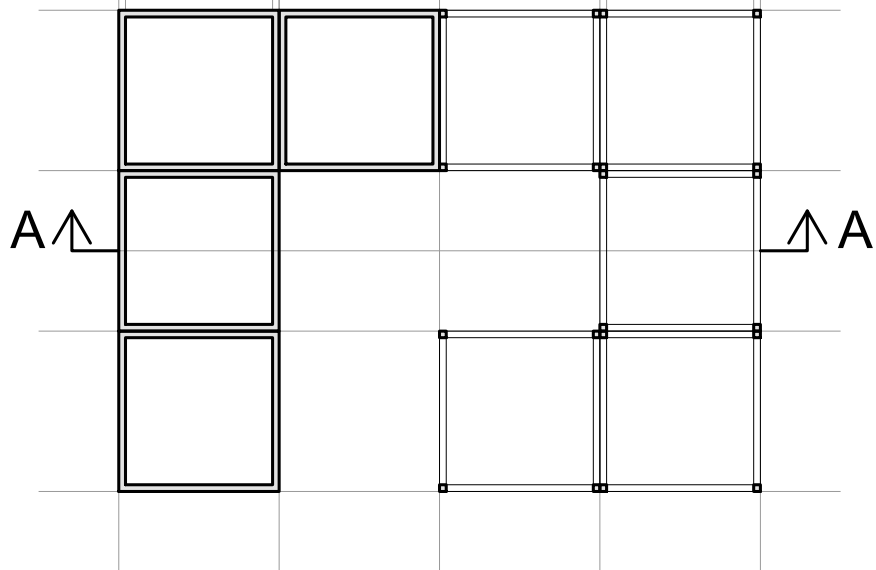

PLANTA NIVEL 0

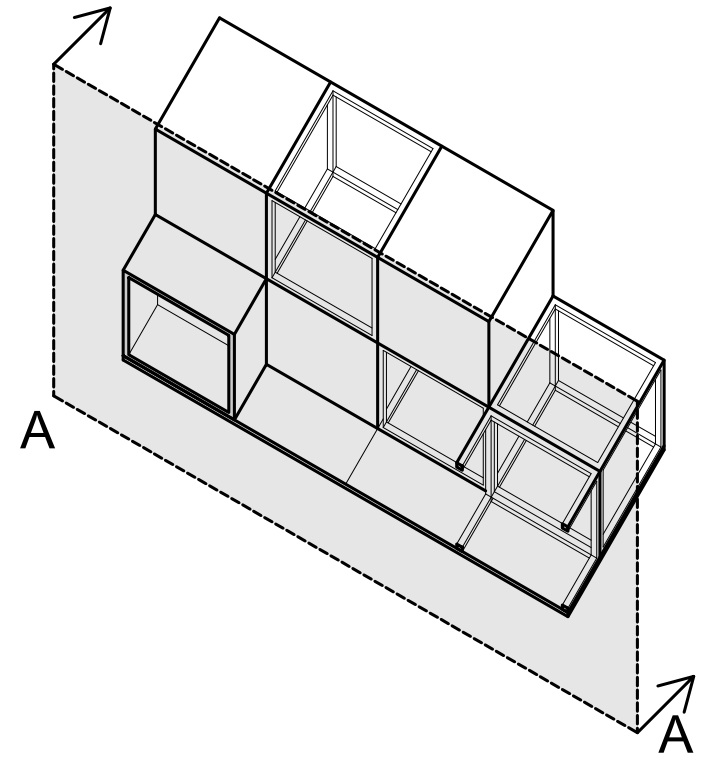

- CORTE
- SECCIÓN

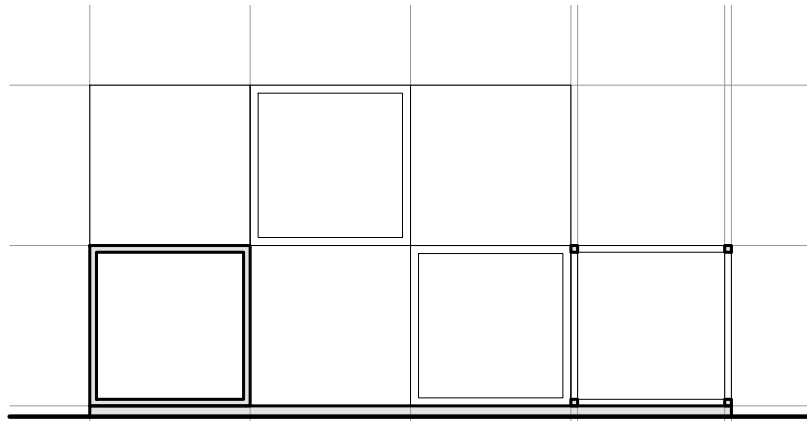

CORTE A-A
Longitudinal

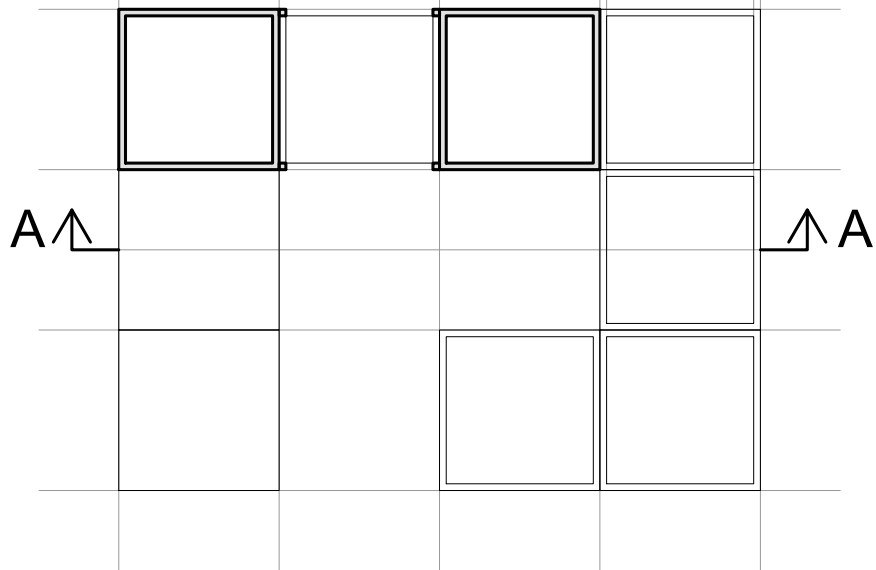

PLANTA NIVEL 1

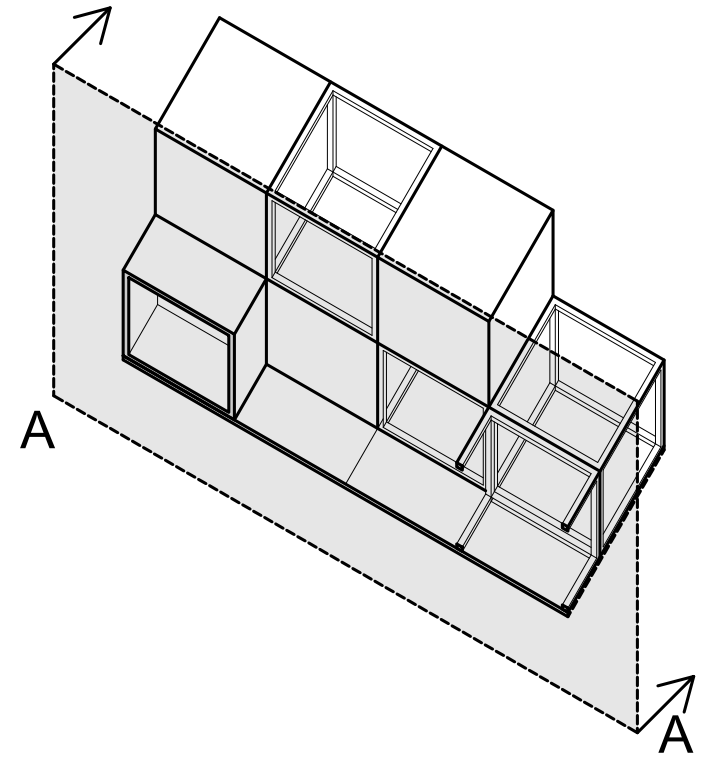

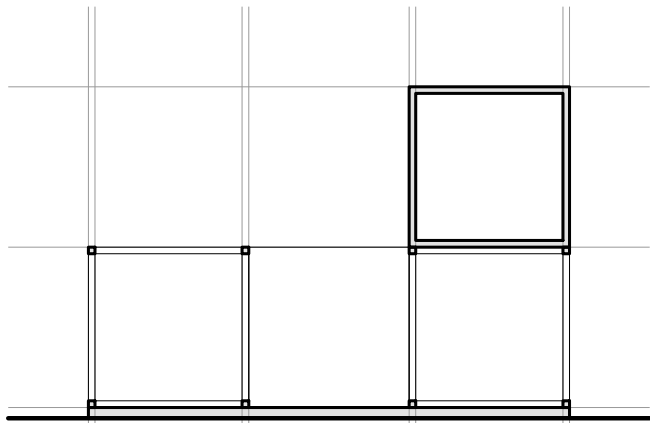

CORTE B-B

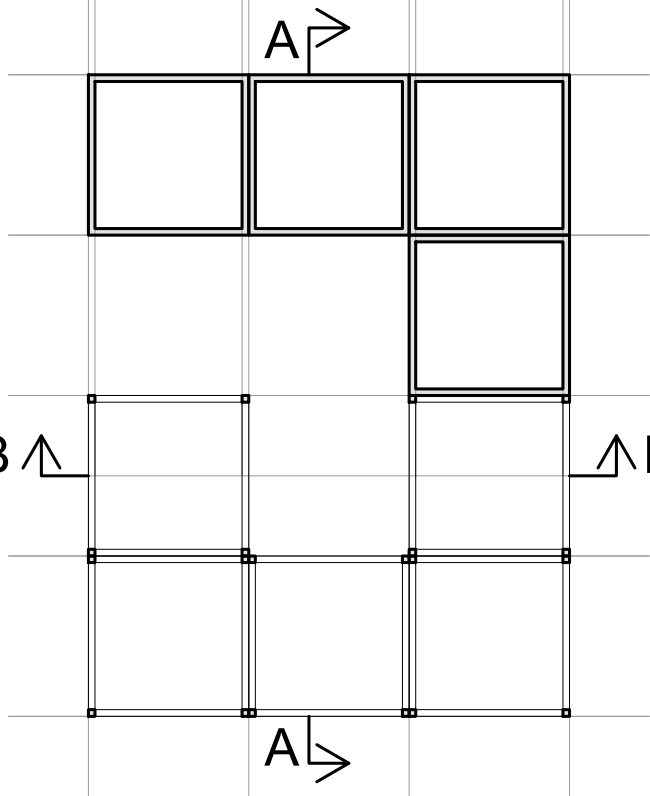

B ↑

A →

↑ B

A →

PLANTA NIVEL 0

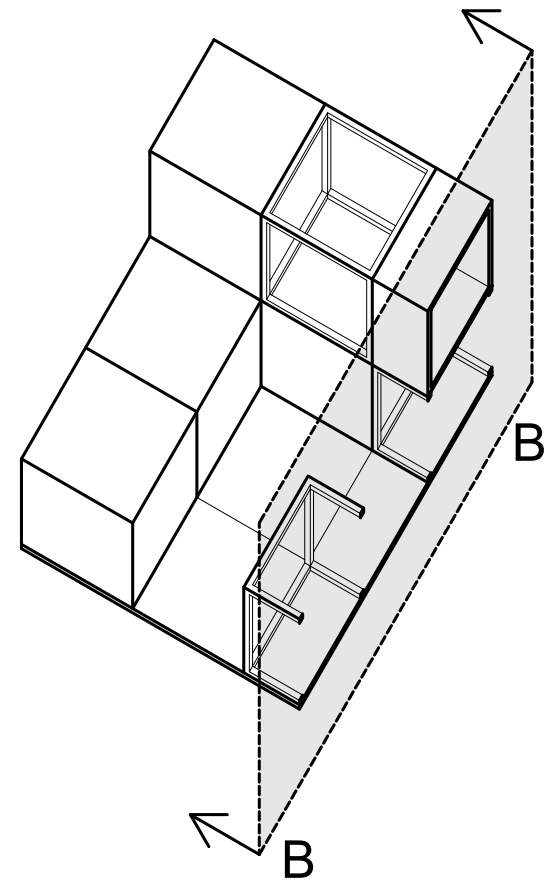

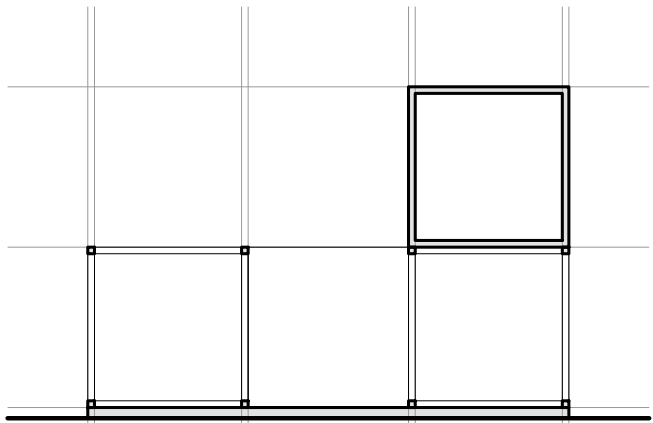

CORTE B-B

A →

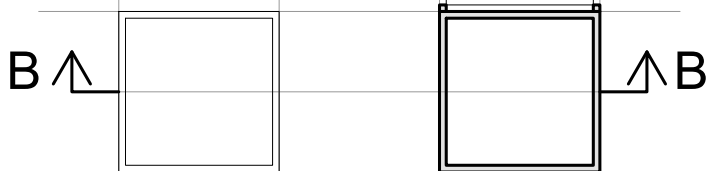

B ↑

↓ B

A →

PLANTA NIVEL 1

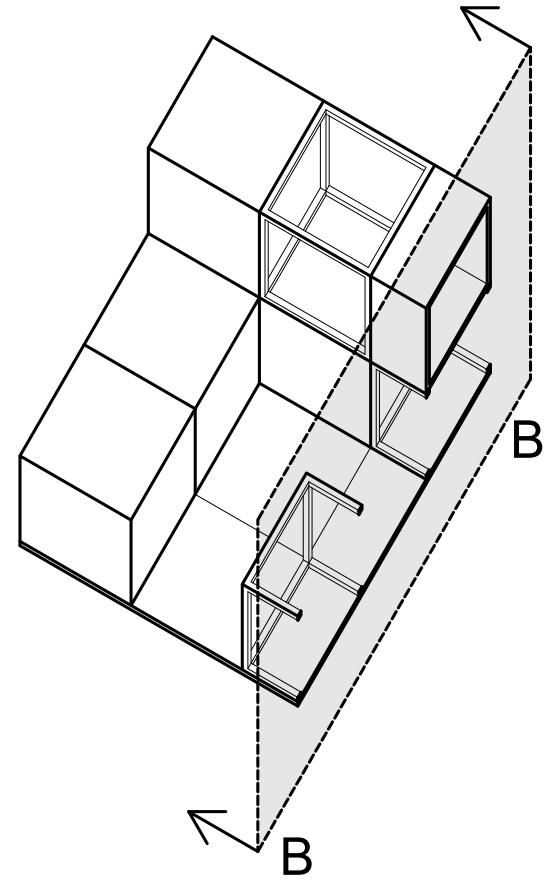

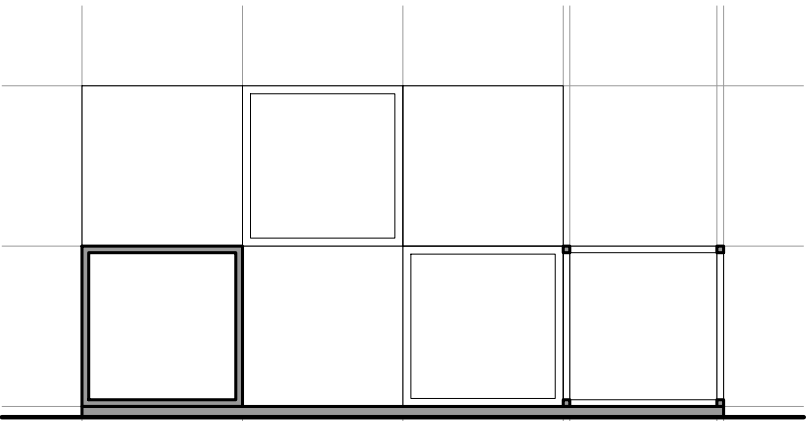

CORTE A-A

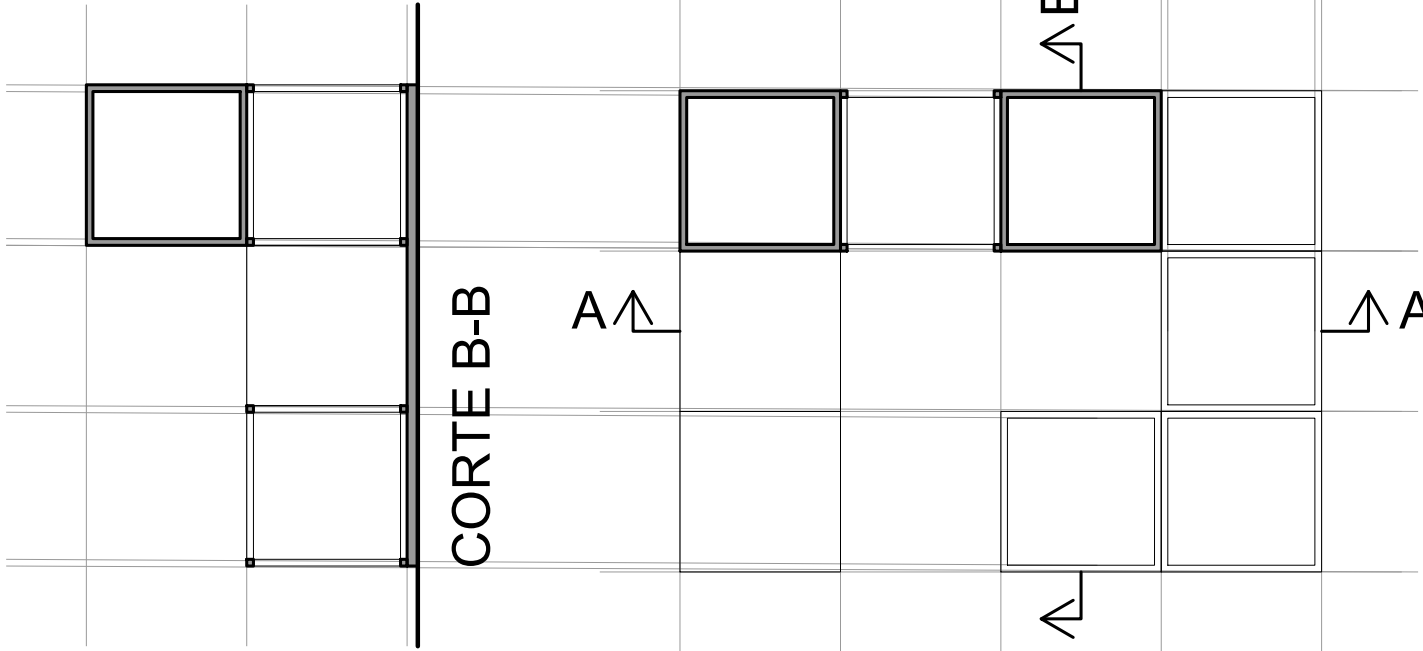





CORTE B-B

A 

B 

A 

-  A-A
-  A-A
-  A-A
-  A-A

PLANTA NIVEL 0

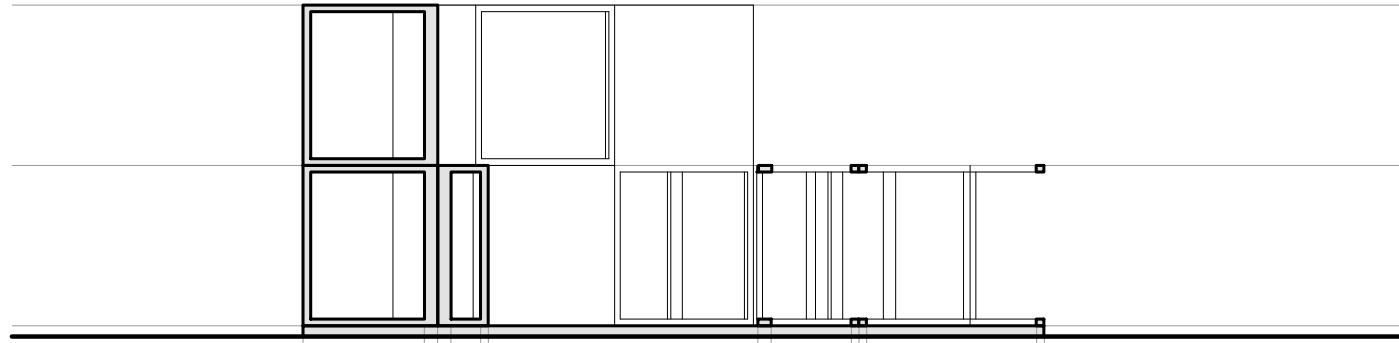

CORTE C-C

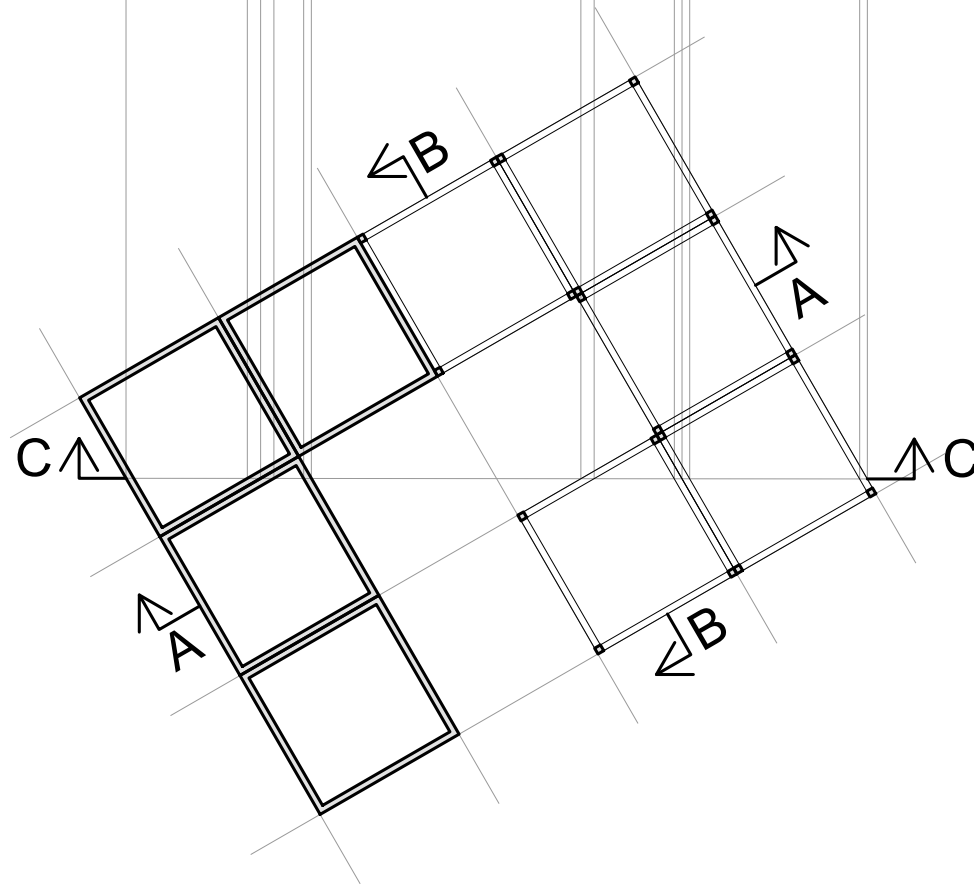

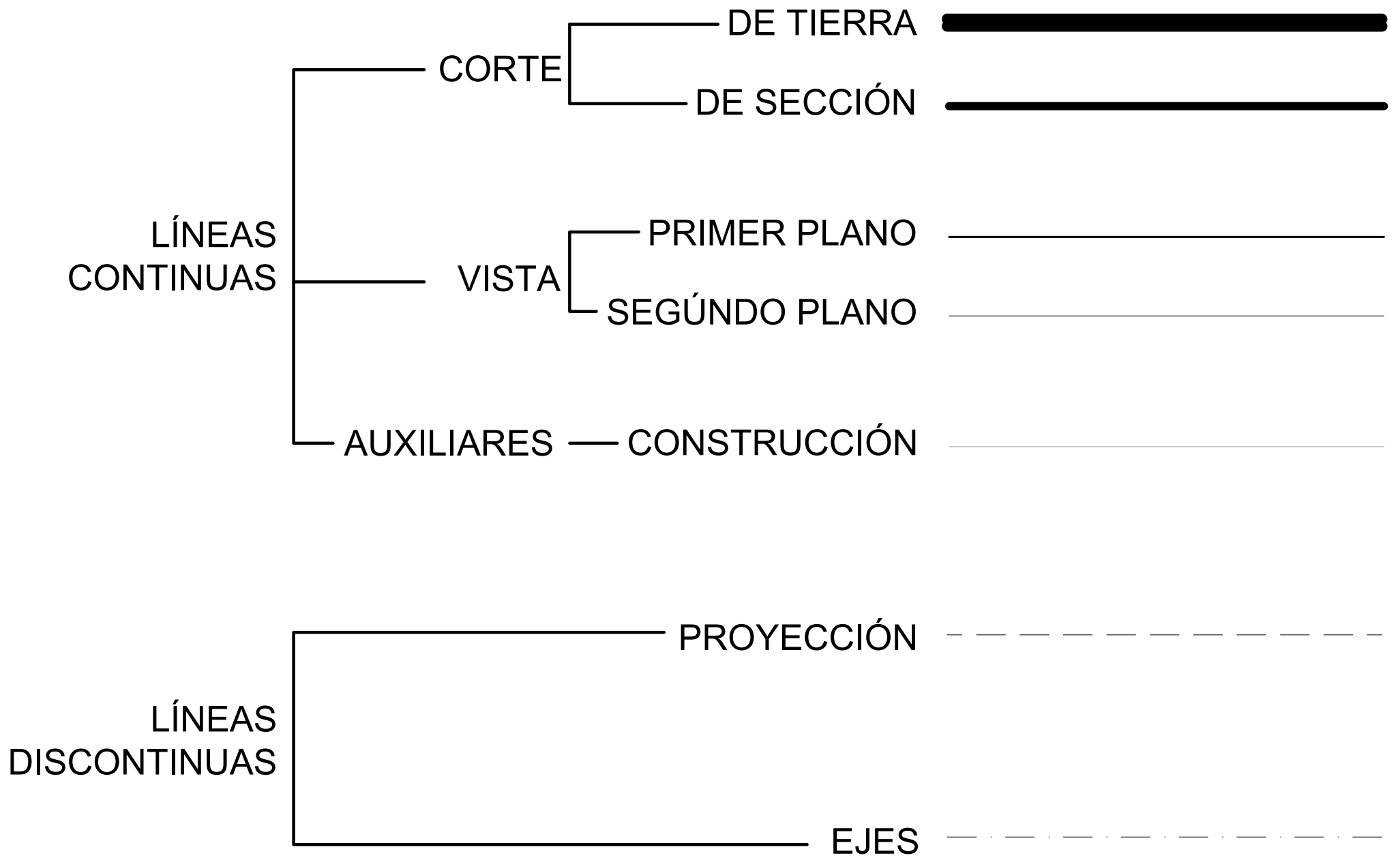

¡Muchas gracias!

